

MINUTE ITEM
This Calendar Item No. 39
was approved as Minute Item
No. 39 by the State Lands
Commission by a vote of 3
to 0 at its 2/6/89
meeting.

CALENDAR ITEM

A 7
S 1

39

02/06/89
W 20953 PRC 7277
J. Ludlow

APPROVAL OF A RECREATIONAL PIER PERMIT

APPLICANT: Reid W. Dennis
225 Mountainwood Lane
Woodside, California 94601

AREA, TYPE LAND AND LOCATION:
A parcel of submerged land in Lake Tahoe, south
of Tahoe City, Placer County.

LAND USE: Reconstruction and maintenance of a pier and
two boathouses.

TERMS OF PROPOSED PERMIT:
Initial period: Ten years beginning January,
1989.

CONSIDERATION: Rent-free pursuant to Section 6503.5 of the
P.R.C.

APPLICANT STATUS:
Applicant is owner of upland.

PREREQUISITE CONDITIONS, FEES AND EXPENSES:
Filing fee and processing costs have been
received.

STATUTORY AND OTHER REFERENCES:
A. P.R.C.: Div. 6, Parts 1 and 2; Div. 13.
B. Cal. Code of Regulations: Title 2, Div. 3;
Title 14, Div. 6.

CALENDAR ITEM NO. 39 (CONT'D)

AB 884: 03/25/89.

OTHER PERTINENT INFORMATION:

1. Pursuant to the Commission's delegation of authority and the State CEQA Guidelines (14 Cal. Code Regs. 15025), the staff has prepared a Proposed Negative Declaration identified as EIR ND 449, State Clearinghouse No. 88101911. Such Proposed Negative Declaration was prepared and circulated for public review pursuant to the provisions of CEQA.

Based upon the Initial Study, the Proposed Negative Declaration, and the comments received in response thereto, there is no substantial evidence that the project will have a significant effect on the environment. (14 Cal. Code Regs. 15074(b))

2. In order to determine the other potential trust uses in the area of the proposed project, the staff contacted representatives of the following agencies: TRPA, Department of Fish and Game, County of Placer, and Tahoe Conservancy. None of these agencies expressed a concern that the proposed project would have a significant effect on trust uses in the area. The agencies did not identify any trust needs which were not being met by existing facilities in the area. Identified trust uses in this area would include swimming, boating, walking along the beach, and views of the lake.

There are piers on both sides of the subject pier.

3. This activity involves lands identified as possessing significant environmental values pursuant to P.R.C. 6370, et seq. Based upon the staff's consultation with the persons nominating such lands and through the CEQA review process, it is the staff's opinion that the project, as proposed, is consistent with its use classification.

CALENDAR ITEM NO. 39 (CONT'D)

4. All permits covering structures in Lake Tahoe will include a condition subsequent that if any structure authorized is found to be in nonconformance with the Tahoe Regional Planning Agency's shorezone ordinance and if any alterations, repairs, or removal required pursuant to said ordinance are not accomplished within the designated time period, then the permit will be automatically terminated, effective upon notice by the State, and the site shall be cleared pursuant to the terms thereof.
5. The County of Placer has received notice of the proposed project and has no objection to the pier reconstruction or to the issuance of the State Lands Commission's permit.

APPROVALS OBTAINED:

Tahoe Regional Planning Agency,
United States Army Corps of Engineers.

EXHIBITS:

- A. Land Description.
- B. Location Map.
- C. Placer County Letter of Consent.
- D. Negative Declaration.

IT IS RECOMMENDED THAT THE COMMISSION:

1. CERTIFY THAT A NEGATIVE DECLARATION, EIR ND 449, STATE CLEARINGHOUSE NO. 88101911, WAS PREPARED FOR THIS PROJECT PURSUANT TO THE PROVISIONS OF THE CEQA AND THAT THE COMMISSION HAS REVIEWED AND CONSIDERED THE INFORMATION CONTAINED THEREIN.
2. DETERMINE THAT THE PROJECT, AS APPROVED, WILL NOT HAVE A SIGNIFICANT EFFECT ON THE ENVIRONMENT.
3. AUTHORIZE ISSUANCE TO REID W. DENNIS OF A TEN-YEAR RECREATIONAL PIER PERMIT BEGINNING DATE OF JANUARY, 1989, FOR THE RECONSTRUCTION, USE AND MAINTENANCE OF ONE RECREATIONAL BOAT DOCK AND TWO BOATHOUSES ON THE LAND DESCRIBED ON EXHIBIT "A" ATTACHED AND BY REFERENCE MADE A PART HEREOF.

EXHIBIT "A"
LAND DESCRIPTION

W 20953

PREPARED DECEMBER 9, 1988 BY BIU 1

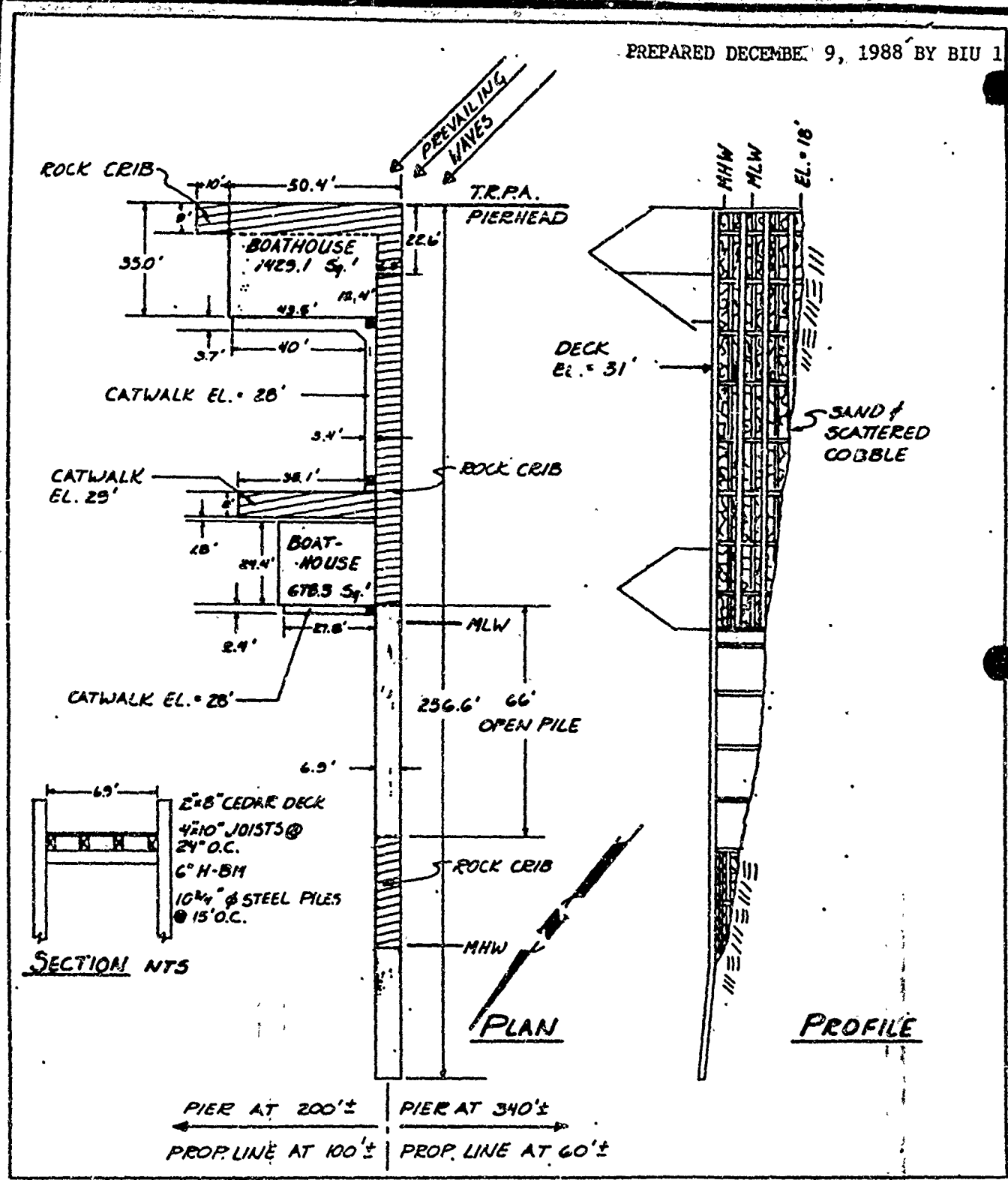

SECTION NTS

PLAN

PROFILE

PIER AT 200'± | PIER AT 340'±
 PROP. LINE AT 100'± | PROP. LINE AT 60'±

RVA RAYMOND VAIL and ASSOCIATES
 305 North Lake Blvd., P.O. Box 879, Tahoe City, CA 95720, (916) 982-2417

ENGINEERS
 ARCHITECTS
 PLANNERS
 SURVEYORS

205
 266

DRAWN BY: JMB
 CHECKED BY: JMB
 DATE: 11/16/1986

DENNIS PIER AND BOATHOUSE REPAIR
 1340 WEST LAKE BLVD.
 PLACER CO. A.P.N. 83-162-12

SCALE Horiz: 1"=40'
 Approx. Vert: 1"=20'
 FILE NO. 7125 29R

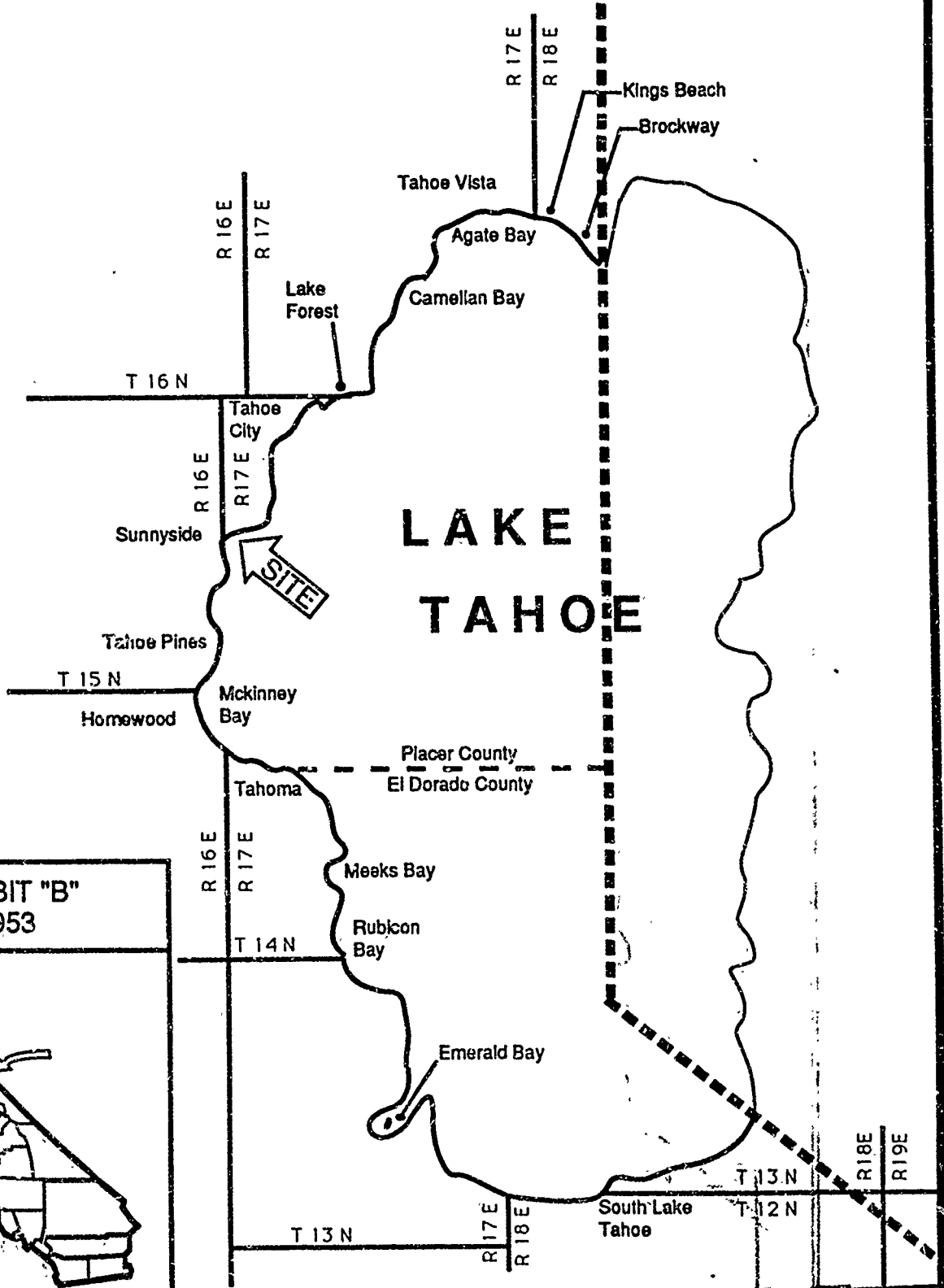

EXHIBIT "B"
W 20953



CALENDAR PAGE	7	206
MINUTE PAGE	7	267



PLACER COUNTY

DEPARTMENT OF PUBLIC WORKS

JACK WARREN, Director
 JAN WITTER, Assistant Director
 LARRY ODDO, Deputy Director
 ALAN ROY, Deputy Director

OPERATING DIVISION

Administration
 Engineering
 Equipment Maintenance
 Road Maintenance
 Special Districts
 Surveying
 Transportation

January 6, 1989

Judy Ludlow
 State Lands Commission
 1807-13th Street
 Sacramento, CA 95814

RE: PIER/SHORE ZONE CONSTRUCTION

The County of Placer has reviewed the below referenced requests for construction activities within the shore zone of Lake Tahoe. We have no objection to the construction activities described in these applications contingent upon approval by your office.

1.	Dale Hanson	APN 85-260-33	W24248
2.	Joseph Harris	APN 116-220-49	W24235
3.	Moana Beach P.O.A.	APN 98-191-11	W24256
4.	John Mozart	APN 98-010-03	PRC6525.9
5.	Reid Dennis	APN 83-162-12	W20953
6.	Fred Damavandi	APN 116-080-04	W24138

If you have any questions, please give me a call at your convenience.

COUNTY OF PLACER
 DEPARTMENT OF PUBLIC WORKS
 JACK WARREN, DIRECTOR

 JAMES A. MCLEOD
 ASSISTANT CIVIL ENGINEER

JAM:as

019/11

EXHIBIT "D"

1. Project Title: DENNIS PIER RECONSTRUCTION
 2. Lead Agency: STATE LANDS COMMISSION 3. Contact Person: TED T. FUKUSHIMA
 4a. Street Address: 1807-13th Street 4b. City: Sacramento
 5. County: Sacramento 3d. Zip: 95814 3e. Phone: (916)322-7813

PROJECT LOCATION 4. County: Placer 4a. City/Community: near Tahoe City
 4b. Assessor's Parcel No.: _____ 4c. Section: _____ 4d. Range: _____
 5a. Cross Streets: _____ 5b. Pct Rural, Nearest Community: _____
 6. Within 2 miles: a. State Hwy # 89 b. Air-ports NO c. Rail-ways NO d. Water-ways Lake Tahoe

7. DOCUMENT TYPE		8. LOCAL ACTION TYPE		9. DEVELOPMENT TYPE	
<u>CDA</u>		01. General Plan Update		01. Residential Units _____ Acres _____	
01. NCP	06. MOE	02. New Element		02. Office, Sq. Ft. _____	
02. Early Cons	07. MOC	03. General Plan Amendment		Acres _____ Employees _____	
03. X Neg Dec	08. MCD	04. Master Plan		03. Shopping/Commercial: Sq. Ft. _____	
04. Draft EIR		05. Annexation		Acres _____ Employees _____	
Supplement/ Subsequent EIR (Provide SCH No.:		06. Specific Plan		04. Industrial: Sq. Ft. _____	
		07. Ordinance Plan		Acres _____ Employees _____	
		08. Redevelopment		05. Water Facilities: MGD _____	
<u>NEPA</u>		09. Rezone		06. Transportation: Type _____	
09. NOI	11. Draft EIS	10. Land Division (Subdivision, Parcel Map, Tract Map, etc.)		07. Mining: Mineral _____	
10. FONSI	12. EA	11. Use Permit		08. Power: Type _____ Watts _____	
<u>OTHER</u>		12. State Land Plan		09. Waste Treatment: Type _____	
13. Joint Document		13. Canceled Preserve		10. CCS Related _____	
14. Final Document		14. _____		11. X Other: <u>pier reconstruction</u>	
15. Other _____					

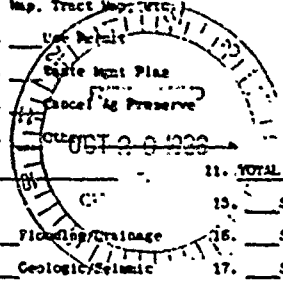

10. TOTAL ACRES: _____ 11. TOTAL JOBS CREATED: _____

12. PROJECT ISSUES DISCUSSED IN DOCUMENT	13. PENDING (approx) Federal \$ _____ State \$ _____ Total \$ _____	14. PRESENT LAND USE AND ZONING:
01. Aesthetic/Visual	08. Flooding/Drainage	15. Septic Systems
02. Agricultural Land	09. Geologic/Seismic	16. Sewer Capacity
03. Air Quality	10. Jobs/Housing Balance	17. Social
04. Archaeological/Historical	11. Minerals	18. Soil Erosion
05. Coastal Zone	12. Noise	19. Solid Waste
06. Economic	13. Public Services	20. Toxic/Hazardous
07. Fire Hazard	14. Schools	21. Traffic/Circulation
		22. Vegetation
		23. Water Quality
		24. Water Supply
		25. Wetland/Riparian
		26. Wildlife
		27. Growth Inducing
		28. Incompatible Landuse
		29. Cumulative Effects
		30. Other _____

15. PROJECT DESCRIPTION: Reconstruction of an existing pier.

CLEARINGHOUSE CONTACT: KEITH LEE W/C N/C
88101911 916-445-0613
 STATE REVIEW BEGAN: 10-20-88
 DEPT REV TO AGENCY: 11-10
 AGENCY REV TO SCH: 11-16
 SCH COMPLIANCE: 11-18
 PLEASE RETURN NOC WITH ALL COMMENTS
 Resources (File Date: 10/22)
 AQD/APCD: _____

DISTRIBUTION LIST

- Resources
- Conservation
- Fish & Game
- Industry
- Information
- Parks & Rec/OHP
- Regional Comm
- Emergency Comm
- State Lands
- Waste
- Res Cnt Bd
- Qual (4TH)
- Rts (3RD)
- nts (2ND)
- er!

W/C N/C

- RWCCB# 6 (TAHOE)
- Caltrans# 3
- ns Planning
- onautics
- ing & Devel
- Health
- d & Ag
- (Schools)
- rections
- General Servs
- stal Conserv
- ta Mn Mtns
- prado Rvr Rd
- Tahoe Rgl Plan
- stal - OPR
- OPR

STATE LANDS COMMISSION

1807 13TH STREET
SACRAMENTO, CALIFORNIA 95814



File Ref.: W 20953

Date: Oct. 20, 1988

NOTICE OF PUBLIC REVIEW
OF A
PROPOSED NEGATIVE DECLARATION
(Section 15073 CAC)

A Proposed Negative Declaration has been prepared pursuant to the requirements of the California Environmental Quality Act (Section 21000 et seq., Public Resources Code), the State CEQA Guidelines (Section 15000, et seq., Title 14, California Administrative Code), and the State Lands Commission regulations (Section 2901 et seq., Title 2, California Administrative Code), for a project currently being processed by the staff of the State Lands Commission.

The document is attached for your review. Comments should be addressed to the State Lands Commission office shown above, with attention to the undersigned. All comments must be received by November 9, 1988.

Should you have any questions or need additional information, please call (916) 322-7813.

ATTACHMENT

Ted T. Fukushima
TED T. FUKUSHIMA

CALENDAR PAGE	209
MINUTE PAGE	270

STATE LANDS COMMISSION
1907 13TH STREET
SACRAMENTO, CALIFORNIA 95814



PROPOSED NEGATIVE DECLARATION

EIR ND 449

File Ref.: W 20953

SCH#: 8810 1911

Project Title: Dennis - Pier Reconstruction

Project Proponent: Reid W. Dennis

Project Location: In Lake Tahoe adjacent to 1340 West Lake Blvd., approximately 1.75 south of Tahoe City, Placer County.

Project Description: Reconstruction of an existing pier.

Contact Person: TED T. FUKUSHIMA

Telephone: (916)322-7813

This document is prepared pursuant to the requirements of the California Environmental Quality Act (Section 21000 et seq., Public Resources Code), the State CEQA Guidelines (Section 15000 et seq., Title 14, California Administrative Code), and the State Lands Commission regulations (Section 2901 et seq., Title 2, California Administrative Code).

Based upon the attached Initial Study, it has been found that:

the project will not have a significant effect on the environment.

mitigation measures included in the project will avoid potentially significant effects.

CALENDAR PAGE	210
MINUTE PAGE	271

ENVIRONMENTAL IMPACT ASSESSMENT FORM -- Part I

(To be completed by applicant)

FORM 69.3(11/82)

A. GENERAL INFORMATION

1. Name, address, and telephone number:

a. Applicant

Reid W. Dennis
225 Mountain Wood Lane
Woodside, CA 94061
(415) 851-0574

b. Contact person if other than applicant:

Kevin M. Aqan
Raymond Vail Associates
395 North Lake Blvd., Tahoe City
(916) 583-3417

2. a. Project location: (Please reference to nearest town or community and include county)

In Lake Tahoe adjacent to 1340 West Lake Blvd., approximately 1.75 miles south of
Tahoe City, Placer County.

b. Assessor's parcel number: 83-162-12

3. Existing zoning of project site: _____

4. Existing land use of project site: Recreational pier

5. Proposed use of site: Same; reconstruction of the pier.

6. Other permits required: Tahoe Regional Planning Agency(obtained), Dept. of Fish & Game(pen-
ding); Regional Water Quality Control Board(obtained)

B. PROJECT DESCRIPTION

1. For building construction projects, complete "ATTACHMENT A".

2. For non-building construction projects: Describe fully, the proposed activity, its purpose and intended use, e.g. for proposed mineral prospecting permits, include the number of test holes, size of holes, amount of material to be excavated, maximum surface area of disturbance, hole locations, depth of holes, etc. Attach plans or other drawings as necessary.

CALENDAR PAGE	<u>211</u>
MINUTE PAGE	<u>272</u>

C. ENVIRONMENTAL SETTING

1. Describe the project site as it exists before the project, including information on topography, soil stability, plants and animals, and any cultural, historical, or scenic aspects. Describe any existing structures on the site, and the use of the structures.
See attached environmental assessment
2. Describe the surrounding properties, including information on plants and animals and any cultural, historical, or scenic aspects. Indicate the type of land use (residential, commercial, etc.), intensity of land use (one-family, apartment houses, shops, department stores, etc.), and scale of development (height, frontage, set-back, rear yard, etc.).

D. ENVIRONMENTAL IMPACT ASSESSMENT

Answer the following questions by placing a check in the appropriate box. Discuss all items checked "yes" or "maybe".
(Attach additional sheets as necessary)

Will the project involve:	YES	MAYBE	NO
1. a change in existing features of any bays, tidelands, beaches, lakes, or hills, or substantial alteration of ground contours?	<input type="checkbox"/>	<input type="checkbox"/>	<input checked="" type="checkbox"/>
2. a change in scenic views or vistas from existing residential areas or public lands or roads?	<input type="checkbox"/>	<input type="checkbox"/>	<input checked="" type="checkbox"/>
3. a change in pattern, scale, or character of the general area of project?	<input type="checkbox"/>	<input type="checkbox"/>	<input checked="" type="checkbox"/>
4. a significant effect on plant or animal life?	<input type="checkbox"/>	<input type="checkbox"/>	<input checked="" type="checkbox"/>
5. significant amounts of solid waste or litter?	<input type="checkbox"/>	<input type="checkbox"/>	<input checked="" type="checkbox"/>
6. a change in dust, ash, smoke, fumes, or odors in the vicinity?	<input type="checkbox"/>	<input type="checkbox"/>	<input checked="" type="checkbox"/>
7. a change in ocean, bay, lake, stream, or ground water quality or quantity, or alteration of existing drainage patterns?	<input type="checkbox"/>	<input type="checkbox"/>	<input checked="" type="checkbox"/>
8. a change in existing noise or vibration levels in the vicinity?	<input checked="" type="checkbox"/>	<input type="checkbox"/>	<input type="checkbox"/>
9. Temporary-during removal of old pier and construction of the new one construction on filled land or on slope of 10 percent or more?	<input type="checkbox"/>	<input type="checkbox"/>	<input checked="" type="checkbox"/>
10. use or disposal of potentially hazardous materials, such as toxic or radioactive substances, flammables, or explosives?	<input type="checkbox"/>	<input type="checkbox"/>	<input checked="" type="checkbox"/>
11. a change in demand for municipal services (police, fire, water, sewage, etc.)?	<input type="checkbox"/>	<input type="checkbox"/>	<input checked="" type="checkbox"/>
12. an increase in fossil fuel consumption (electricity, oil, natural gas, etc.)?	<input type="checkbox"/>	<input type="checkbox"/>	<input checked="" type="checkbox"/>
13. a larger project or a series of projects?	<input type="checkbox"/>	<input type="checkbox"/>	<input checked="" type="checkbox"/>

E. CERTIFICATION

I hereby certify that the statements furnished above and in the attached exhibits present the data and information required for this initial evaluation to the best of my ability, and that the facts, statements, and information presented are true and correct to the best of my knowledge and belief.

Date: _____

Signed: _____

CALENDAR PAGE	212
MINUTE PAGE	273

ENVIRONMENTAL IMPACT ASSESSMENT CHECKLIST - PART II

Form 13.20 (7/82)

File Ref.: W 20953

I. BACKGROUND INFORMATION

A. Applicant: Reid W. Dennis
225 Mountainwood Lane
Woodside, CA 94061

B. Checklist Date: 10 / 19 / 88

C. Contact Person: TED T. FUKUSHIMA
Telephone: (916) 322-7813

D. Purpose: Reconstruction and continued use and maintenance of an existing pier.

E. Location: In Lake Tahoe adjacent to 1340 West Lake Blvd., approximately 1.75 miles south of Tahoe City, Placer County.

F. Description: Reconstruction of an existing pier.

G. Persons Contacted:

II. ENVIRONMENTAL IMPACTS. (Explain all "yes" and "maybe" answers)

- A. Earth. Will the proposal result in:
1. Unstable earth conditions or changes in geologic substructures?
2. Disruptions, displacements, compaction, or overcovering of the soil?
3. Change in topography or ground surface relief features?
4. The destruction, covering, or modification of any unique geologic or physical features?
5. Any increase in wind or water erosion of soils, either on or off the site?
6. Changes in deposition or erosion of beach sands, or changes in siltation, deposition or erosion which may modify the channel of a river or stream or the bed of the ocean or any bay, inlet, or lake?
7. Exposure of all people or property to geologic hazards such as earthquakes, landslides, mudslides, ground failure, or similar hazards?

CALENDAR PAGE 273
MINUTE PAGE 274

- | | | Yes | Maybe | No |
|---|---|--------------------------|-------------------------------------|-------------------------------------|
| B. Air. Will the proposal result in: | | | | |
| 1. | Substantial air emissions or deterioration of ambient air quality? | <input type="checkbox"/> | <input type="checkbox"/> | <input checked="" type="checkbox"/> |
| 2. | The creation of objectionable odors? | <input type="checkbox"/> | <input type="checkbox"/> | <input checked="" type="checkbox"/> |
| 3. | Alteration of air movement, moisture or temperature, or any change in climate, either locally or regionally? | <input type="checkbox"/> | <input type="checkbox"/> | <input checked="" type="checkbox"/> |
| C. Water. Will the proposal result in: | | | | |
| 1. | Changes in the currents, or the course or direction of water movements, in either marine or fresh waters? | <input type="checkbox"/> | <input type="checkbox"/> | <input checked="" type="checkbox"/> |
| 2. | Changes in absorption rates, drainage patterns, or the rate and amount of surface water runoff? | <input type="checkbox"/> | <input type="checkbox"/> | <input checked="" type="checkbox"/> |
| 3. | Alterations to the course or flow of flood waters? | <input type="checkbox"/> | <input type="checkbox"/> | <input checked="" type="checkbox"/> |
| 4. | Change in the amount of surface water in any water body? | <input type="checkbox"/> | <input type="checkbox"/> | <input checked="" type="checkbox"/> |
| 5. | Discharge into surface waters, or in any alteration of surface water quality, including but not limited to temperature, dissolved oxygen or turbidity? | <input type="checkbox"/> | <input type="checkbox"/> | <input checked="" type="checkbox"/> |
| 6. | Alteration of the direction or rate of flow of ground waters? | <input type="checkbox"/> | <input type="checkbox"/> | <input checked="" type="checkbox"/> |
| 7. | Change in the quantity of ground waters, either through direct additions or withdrawals, or through interception of an aquifer by cuts or excavations? | <input type="checkbox"/> | <input type="checkbox"/> | <input checked="" type="checkbox"/> |
| 8. | Substantial reduction in the amount of water otherwise available for public water supplies? | <input type="checkbox"/> | <input type="checkbox"/> | <input checked="" type="checkbox"/> |
| 9. | Exposure of people or property to water-related hazards such as flooding or tidal waves? | <input type="checkbox"/> | <input type="checkbox"/> | <input checked="" type="checkbox"/> |
| 10. | Significant changes in the temperature, flow or chemical content of surface thermal springs? | <input type="checkbox"/> | <input type="checkbox"/> | <input checked="" type="checkbox"/> |
| D. Plant Life. Will the proposal result in: | | | | |
| 1. | Change in the diversity of species, or number of any species of plants (including trees, shrubs, grass, crops, and aquatic plants)? | <input type="checkbox"/> | <input type="checkbox"/> | <input checked="" type="checkbox"/> |
| 2. | Reduction of the numbers of any unique, rare or endangered species of plants? | <input type="checkbox"/> | <input type="checkbox"/> | <input checked="" type="checkbox"/> |
| 3. | Introduction of new species of plants into an area, or in a barrier to the normal replenishment of existing species? | <input type="checkbox"/> | <input type="checkbox"/> | <input checked="" type="checkbox"/> |
| 4. | Reduction in acreage of any agricultural crop? | <input type="checkbox"/> | <input type="checkbox"/> | <input checked="" type="checkbox"/> |
| E. Animal Life. Will the proposal result in: | | | | |
| 1. | Change in the diversity of species, or numbers of any species of animals (birds, land animals including reptiles, fish and shellfish, benthic organisms, or insects)? | <input type="checkbox"/> | <input type="checkbox"/> | <input checked="" type="checkbox"/> |
| 2. | Reduction of the numbers of any unique, rare or endangered species of animals? | <input type="checkbox"/> | <input type="checkbox"/> | <input checked="" type="checkbox"/> |
| 3. | Introduction of new species of animals into an area, or result in a barrier to the migration or movement of animals? | <input type="checkbox"/> | <input type="checkbox"/> | <input checked="" type="checkbox"/> |
| 4. | Deterioration to existing fish or wildlife habitat? | <input type="checkbox"/> | <input type="checkbox"/> | <input checked="" type="checkbox"/> |
| F. Noise. Will the proposal result in: | | | | |
| 1. | Increase in existing noise levels? | <input type="checkbox"/> | <input checked="" type="checkbox"/> | <input type="checkbox"/> |
| 2. | Exposure of people to severe noise levels? | <input type="checkbox"/> | <input type="checkbox"/> | <input checked="" type="checkbox"/> |
| G. Light and Glare. Will the proposal result in: | | | | |
| 1. | The production of new light or glare? | <input type="checkbox"/> | <input type="checkbox"/> | <input checked="" type="checkbox"/> |
| H. Land Use. Will the proposal result in: | | | | |
| 1. | A substantial alteration of the present or planned land use of an area? | <input type="checkbox"/> | <input type="checkbox"/> | <input checked="" type="checkbox"/> |
| I. Natural Resources. Will the proposal result in: | | | | |
| 1. | Increase in the rate of use of any natural resources? | <input type="checkbox"/> | <input type="checkbox"/> | <input checked="" type="checkbox"/> |
| 2. | Substantial depletion of any nonrenewable resources? | <input type="checkbox"/> | <input type="checkbox"/> | <input checked="" type="checkbox"/> |

- J. Risk of Upset:** Does the proposal result in:
- | | Yes | Maybe | No |
|---|--------------------------|--------------------------|-------------------------------------|
| 1. A risk of an explosion or the release of hazardous substances (including, but not limited to, oil, pesticides, chemicals, or radiation) in the event of an accident or upset conditions? | <input type="checkbox"/> | <input type="checkbox"/> | <input checked="" type="checkbox"/> |
| 2. Possible interference with emergency response plan or an emergency evacuation plan? | <input type="checkbox"/> | <input type="checkbox"/> | <input checked="" type="checkbox"/> |
- K. Population.** Will the proposal result in:
- | | | | |
|---|--------------------------|--------------------------|-------------------------------------|
| 1. The alteration, distribution, density, or growth rate of the human population of the area? | <input type="checkbox"/> | <input type="checkbox"/> | <input checked="" type="checkbox"/> |
|---|--------------------------|--------------------------|-------------------------------------|
- L. Housing.** Will the proposal result in:
- | | | | |
|---|--------------------------|--------------------------|-------------------------------------|
| 1. Affecting existing housing, or create a demand for additional housing? | <input type="checkbox"/> | <input type="checkbox"/> | <input checked="" type="checkbox"/> |
|---|--------------------------|--------------------------|-------------------------------------|
- M. Transportation/Circulation.** Will the proposal result in:
- | | | | |
|---|--------------------------|--------------------------|-------------------------------------|
| 1. Generation of substantial additional vehicular movement? | <input type="checkbox"/> | <input type="checkbox"/> | <input checked="" type="checkbox"/> |
| 2. Affecting existing parking facilities, or create a demand for new parking? | <input type="checkbox"/> | <input type="checkbox"/> | <input checked="" type="checkbox"/> |
| 3. Substantial impact upon existing transportation systems? | <input type="checkbox"/> | <input type="checkbox"/> | <input checked="" type="checkbox"/> |
| 4. Alterations to present patterns of circulation or movement of people and/or goods? | <input type="checkbox"/> | <input type="checkbox"/> | <input checked="" type="checkbox"/> |
| 5. Alterations to waterborne, rail, or air traffic? | <input type="checkbox"/> | <input type="checkbox"/> | <input checked="" type="checkbox"/> |
| 6. Increase in traffic hazards to motor vehicles, bicyclists, or pedestrians? | <input type="checkbox"/> | <input type="checkbox"/> | <input checked="" type="checkbox"/> |
- N. Public Services.** Will the proposal have an effect upon, or result in a need for new or altered governmental services in any of the following areas:
- | | | | |
|---|--------------------------|--------------------------|-------------------------------------|
| 1. Fire protection? | <input type="checkbox"/> | <input type="checkbox"/> | <input checked="" type="checkbox"/> |
| 2. Police protection? | <input type="checkbox"/> | <input type="checkbox"/> | <input checked="" type="checkbox"/> |
| 3. Schools? | <input type="checkbox"/> | <input type="checkbox"/> | <input checked="" type="checkbox"/> |
| 4. Parks and other recreational facilities? | <input type="checkbox"/> | <input type="checkbox"/> | <input checked="" type="checkbox"/> |
| 5. Maintenance of public facilities, including roads? | <input type="checkbox"/> | <input type="checkbox"/> | <input checked="" type="checkbox"/> |
| 6. Other governmental services? | <input type="checkbox"/> | <input type="checkbox"/> | <input checked="" type="checkbox"/> |
- O. Energy.** Will the proposal result in:
- | | | | |
|---|--------------------------|--------------------------|-------------------------------------|
| 1. Use of substantial amounts of fuel or energy? | <input type="checkbox"/> | <input type="checkbox"/> | <input checked="" type="checkbox"/> |
| 2. Substantial increase in demand upon existing sources of energy, or require the development of new sources? | <input type="checkbox"/> | <input type="checkbox"/> | <input checked="" type="checkbox"/> |
- P. Utilities.** Will the proposal result in a need for new systems, or substantial alterations to the following utilities:
- | | | | |
|------------------------------------|--------------------------|--------------------------|-------------------------------------|
| 1. Power or natural gas? | <input type="checkbox"/> | <input type="checkbox"/> | <input checked="" type="checkbox"/> |
| 2. Communication systems? | <input type="checkbox"/> | <input type="checkbox"/> | <input checked="" type="checkbox"/> |
| 3. Water? | <input type="checkbox"/> | <input type="checkbox"/> | <input checked="" type="checkbox"/> |
| 4. Sewer or septic tanks? | <input type="checkbox"/> | <input type="checkbox"/> | <input checked="" type="checkbox"/> |
| 5. Storm water drainage? | <input type="checkbox"/> | <input type="checkbox"/> | <input checked="" type="checkbox"/> |
| 6. Solid waste and disposal? | <input type="checkbox"/> | <input type="checkbox"/> | <input checked="" type="checkbox"/> |
- Q. Human Health.** Will the proposal result in:
- | | | | |
|--|--------------------------|--------------------------|-------------------------------------|
| 1. Creation of any health hazard or potential health hazard (excluding mental health)? | <input type="checkbox"/> | <input type="checkbox"/> | <input checked="" type="checkbox"/> |
| 2. Exposure of people to potential health hazards? | <input type="checkbox"/> | <input type="checkbox"/> | <input checked="" type="checkbox"/> |
- R. Aesthetics.** Will the proposal result in:
- | | | | |
|--|--------------------------|--------------------------|-------------------------------------|
| 1. The obstruction of any scenic vista or view open to the public, or will the proposal result in the creation of an aesthetically offensive site open to public view? | <input type="checkbox"/> | <input type="checkbox"/> | <input checked="" type="checkbox"/> |
|--|--------------------------|--------------------------|-------------------------------------|
- S. Recreation.** Will the proposal result in:
- | | | | |
|---|--------------------------|--------------------------|-------------------------------------|
| 1. An impact upon the quality or quantity of existing recreational opportunities? | <input type="checkbox"/> | <input type="checkbox"/> | <input checked="" type="checkbox"/> |
|---|--------------------------|--------------------------|-------------------------------------|

T. Cultural Resources

- | | Yes | Maybe | No |
|---|--------------------------|--------------------------|-------------------------------------|
| 1. Will the proposal result in the alteration of or the destruction of a prehistoric or historic archeological site? | <input type="checkbox"/> | <input type="checkbox"/> | <input checked="" type="checkbox"/> |
| 2. Will the proposal result in adverse physical or aesthetic effects to a prehistoric or historic building, structure, or object? | <input type="checkbox"/> | <input type="checkbox"/> | <input checked="" type="checkbox"/> |
| 3. Does the proposal have the potential to cause a physical change which would affect unique ethnic cultural values? | <input type="checkbox"/> | <input type="checkbox"/> | <input checked="" type="checkbox"/> |
| 4. Will the proposal restrict existing religious or sacred uses within the potential impact area? | <input type="checkbox"/> | <input type="checkbox"/> | <input checked="" type="checkbox"/> |

U. Mandatory Findings of Significance.

- | | | | |
|--|--------------------------|--------------------------|-------------------------------------|
| 1. Does the project have the potential to degrade the quality of the environment, reduce the habitat of a fish or wildlife species, cause a fish or wildlife population to drop below self-sustaining levels, threaten to eliminate a plant or animal community, reduce the number or restrict the range of a rare or endangered plant or animal or eliminate important examples of the major periods of California history or prehistory? | <input type="checkbox"/> | <input type="checkbox"/> | <input checked="" type="checkbox"/> |
| 2. Does the project have the potential to achieve short term, to the disadvantage of long-term, environmental goals? | <input type="checkbox"/> | <input type="checkbox"/> | <input checked="" type="checkbox"/> |
| 3. Does the project have impacts which are individually limited, but cumulatively considerable? | <input type="checkbox"/> | <input type="checkbox"/> | <input checked="" type="checkbox"/> |
| 4. Does the project have environmental effects which will cause substantial adverse effects on human beings, either directly or indirectly? | <input type="checkbox"/> | <input type="checkbox"/> | <input checked="" type="checkbox"/> |

III. DISCUSSION OF ENVIRONMENTAL EVALUATION (See Comments Attached)

F1 - The project would increase the noise level during the removal of the existing pier and the construction of the new pier.

IV. PRELIMINARY DETERMINATION

On the basis of this initial evaluation:

- I find the proposed project COULD NOT have a significant effect on the environment, and a NEGATIVE DECLARATION will be prepared.
- I find that although the proposed project could have a significant effect on the environment, there will not be a significant effect in this case because the mitigation measures described on an attached sheet have been added to the project. A NEGATIVE DECLARATION will be prepared.
- I find the proposed project MAY have a significant effect on the environment, and an ENVIRONMENTAL IMPACT REPORT is required.

Date: 10 / 19 / 88

David L. Yukushima
For the State Lands Commission

CALENDAR PAGE	216
MINUTE PAGE	277

0.324

ENVIRONMENTAL ASSESSMENT

Reconstruction of a Rock Crib Pier
Reid Dennis, Owner

January 11, 1988

Prepared by:

Stanford L. Loeb, Ph.D.
Consultant
515 Dexter Lane
West Lafayette, Indiana 47906

CALENDAR PAGE	217
MINUTE PAGE	278

TABLE OF CONTENTS

	Page
List of Tables and Figures	11
1. Introduction	1
2. Present Environment	3
3. Water Quality	5
4. Fish Habitat and Fishies in General	6
5. Sediment Transport	8
6. Shoreline Erosion	12
7. Mitigation of Any Potential Environmental Impacts	13
8. Alternatives to Reconstruction	14
9. References	17
10. Photographs of Pier and Sediments	18

LIST OF TABLES AND FIGURES

	Page
Table 1. Sediment organic matter content	11
Figure 1. Location of proposed reconstruction project (1340 W. Lake Blvd., Tahoe City, Placer County, California, A.P.N. 83-162-12).	2
Figure 2. Bathymetric measurements around rock crib pier.	10

1. Introduction

Mr. Reid Dennis is proposing to repair the rock crib pier and boathouse which extends into Lake Tahoe adjacent to his property (1340 W. Lake Blvd., Tahoe City, Placer County, California, A.P.N. 83-162-12) (Figure 1). The purpose of the proposed project is to insure the safety of those using the structure which has decayed due to natural causes over the years. The following presentation is an assessment of the environmental conditions in the area and the possible impacts the proposed repair project will have on the environment.

The material included in this report was in part derived from three site visits (October 5, November 7, 8, 1987) during which the pier and associated structures, the area's benthic composition, fisheries and present environment were examined. On the two latter visits, SCUBA was used to examine the underwater conditions of the littoral zone and pier. Bathymetric measurements, sediment samples and photos were taken during those visits. Relevant scientific literature was also reviewed and individuals with backgrounds in fisheries, sediment transport and water quality were queried to provide background and additional information concerning the proposed project.

The following sections of this report will address the individual areas of concern as outlined by the Tahoe Regional Planning Agency. These areas include: present environment, water quality, fish habitat and fisheries in general, sediment transport, shoreline erosion, mitigation of any potential impacts including those which are construction (reconstruction in this case) related, and alternatives to reconstruction. Other agencies expressed their concerns about projects

Figure 1. Location of the proposed reconstruction project (1340 W. Lake Blvd., Tahoe City, Placer County, California, A.P.N. 83-162-12).

CALENDAR PAGE	221
MINUTE PAGE	282

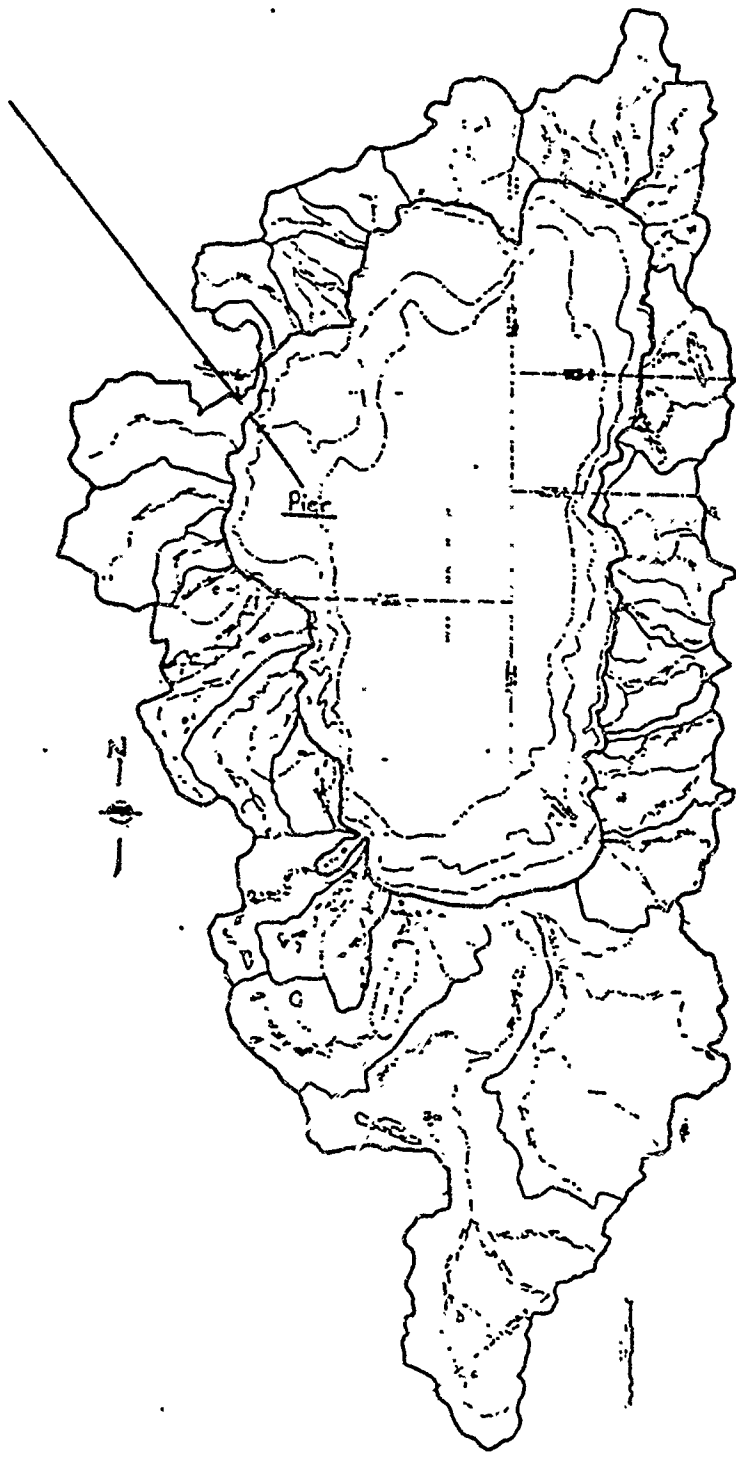

CALENDAR PAGE	222
MINUTE PAGE	283

of this nature and many were contacted to inform them of the preparation of this environmental assessment report. All agencies requested a copy of this report upon its completion for their review. These agencies include: California Department of Fish and Game, Lahontan Regional Water Quality Control Board, California State Lands Commission, and the United States Corp of Engineers.

2. Present Environment

The location of the project is approximately 1.75 mi south of Tahoe City in Placer County (Figure 1). The inflow of Ward Creek is 1.25 mi. south of the project. The shoreline is heavily vegetated with aspen (Populus tremuloides), pine (Pinus murrayana and P. jeffreyi), and fir (Abies concolor) trees with numerous shrubs (e.g., Amelanchier alnifolia, Ceanothus spp., Arctostaphylos sp.). From the high water line to approximately the 6,223 ft. elevation contour, the substrata on the beach and in the lake are cobbles (1-12" diam.). The very nearshore area cobble substrata exist on both sides of the pier structure. Scattered cobbles are found out deeper although the substrata from 6,223 out into the lake is almost uniformly all sand-silty sediments. The overall bathymetry of the littoral area of the project is slight sloping (ca. 5%) out away from shore approximately 500-600 ft. followed by a steeper slope (ca. 10-18%) out to approximately 0.75 mi.

The existing water quality is very clean and oligotrophic. At a water quality monitoring station approximately 0.5 mi. south, the average annual nitrate-nitrogen concentration in the littoral zone was 4 ug/liter; phosphorus (soluble reactive), 3 ug/liter; iron (biologically available), 4 ug/liter (1985-1987) (Loeb, 1987). Water temperatures

generally range from 5-18°C in this area of the lake's littoral region.

During the site visits, the existing habitat around the rock crib pier was found to support minnows (Richardsonius egregius) and crayfish (Pacifastacus leniusculus). A school of approximately 20 minnow were observed adjacent to the pier which, when disturbed, moved into the rock cribbing for refuge. Only crayfish tracks in the sediments were observed although this environment is particularly well suited for crayfish (e.g., cobbles and the rock cribbing). On the shore adjacent to the pier were raccoon tracks which also use crayfish as a food item. The habitat is also suitable for other aquatic animals of the lake such as rainbow trout (Salmo gairdnerii), sculpin (Cottus sp.), mountain whitefish (Prosopium williamsoni) and the Lahontan mountain sucker (e.g., Pantosteus lahontan) although none were observed. It is not known whether the brown trout (Salmo trutta) or mackinaw trout (Salvelinus namaycush) utilize these shallow (~ 0-15 ft.) waters. The kokanee salmon (Oncorhynchus nerka) is not believed to be present in this area, rather, are more restricted to the south and southwestern shores of Lake Tahoe.

The water currents along the shoreline were not determined during this evaluation. Sediment transport characteristics have previously been studied for this area and have been described to be northward, parallel to the shore (Osborne et al., 1985). The specific area of the pier is very close to what has been described as a "sublacustrine canyon head, which may serve as a littoral sediment barrier" (approximately 2,000 ft. south of the proposed project). Further details concerning the possible interference of the rock crib pier with

longshore currents and sediment transport will be discussed in more detail later in this report. It should be noted that in the earlier study of littoral sediment drift in Lake Tahoe (Osborne et al., 1985), the shallow transport was characterized as highly segmented or compartmentalized along the shore. Therefore, the information presented in this report is relatively restricted to the specific location of this project.

3. Water Quality

The water quality of the littoral area where the pier is situated was described in the previous section (Section 1). The impact of the existing rock crib pier and the potential impact of the reconstruction activity on water quality will be addressed here.

Moreover, the existence of the pier has no deleterious effect on water quality. At best, the increased surface area provided by the rocks within the cribs would allow colonization by attached algae (periphyton) and other organisms which can utilize nutrients in the lake waters. While some of these nutrients may be recycled back into the lake water through decomposition or grazing, a part would be tied up in the sediments and biomass of the grazing organisms. Overall, there should be no water quality problems in this area of the lake associated with the pier structure per se.

During the proposed reconstruction project, the majority of the work will not disturb the sediments. The minimum elevation to which the crib wood replacement is to be made is 6,224.00 ft. The two cribs nearest the shore (cribs K and J, Figure 2) were out of the water during the site visits (October-November, 1987). Piling the crib rocks on the

beach while the wood is replaced should be done carefully to insure that this activity does not contribute any material (e.g., sediments and nutrients) into the lake. The next lakeward crib (crib I) contacts the lake sediments at an elevation of 6,222.74. All wood removal and reconstruction on the cribs from here out into the lake will be above the sediments and, therefore, should not disturb them.

If possible, all rocks when removed should be kept off the lake sediments to minimize any potential disturbance of the nutrients and fine silts the sediments contain. Potential water quality problems associated with this project should be greatly reduced or eliminated if disturbance of the sediments is avoided.

4. Fish Habitat and Fisheries in General

In an earlier section, the conditions of the existing environment were described (Section 1). The general littoral region along the northwest shore has been classified by the California Department of Fish and Game and the Tahoe Regional Planning Agency (TRPA) as fish habitat. Within the TRPA thresholds for the Tahoe basin, two issues specifically apply to the lake's fish habitat: (1) there will be a non-degradation standard in fish habitat, and (2) efforts will be made to improve approximately 3,000 areas of excellent fish habitat to add to the existing approximate 2,776 acres. A history of how the existing fishery in Lake Tahoe developed will not be covered in this report; however, a summary can be found in the proceedings of the TRPA sponsored symposium on "Fisheries and fish habitat in Lake Tahoe" (TRPA, 1986).

The habitat around the proposed project is a band of cobbles along the shoreline extending out about 40-100 ft. (elevation ca. 6,222 ft.).

(The cobble zone varies in width along the shoreline as the lake level fluctuates.) The bottom substratum outward into the lake after the rock cobbles and is uniformly sand or fine grain inorganic sediments (see section 4). The habitat is relatively shallow well beyond the end of the pier (waters depth ~ 20 ft., 500-600 ft. offshore).

The existing habitat does not appear to have been modified significantly by the long time existence of the rock crib pier. Benthic habitat on each side of the pier appears virtually identical in composition. The rock cribbing probably, to some extent, improved the previous habitat in this area. The rocks provide a place of refuge for young fish fry and minnows and increased the amount of surfaces for attached algae (periphyton) to grow. In turn, the periphyton community can support a population of invertebrates, organisms utilized in the food web of fish.

These benefits are not meant to support or justify any increased use of rock crib piers in Lake Tahoe, rather they simply are the consequences of the structure. Increasing the available rock substrate in the littoral, especially where there are none, is currently being tested by the Fish and Game Department together with the Forest Service, Tahoe Conservancy and the TRPA. The objective of that study is to determine the effect of introduced artificial reefs (rocks) on the fisheries of Lake Tahoe (currently being tested in the southwest corner of the lake: pers. comm. Mr. R. Wickwire, C.F.G.D., Mr. J. Reiner, USFS). These new substrata are generally placed in the littoral at depths of 20 ft. or greater.

The proposed pier reconstruction project will have no negative

impacts on the fish habitat or fisheries. Spawning activities of the lake's game and non-game fish are probably minimal in the project area although the activity is possible. Most spawning by the brown trout (Salmo trutta), rainbow trout (Salmo gairdnerii), whitefish (Prosopium williamsoni) and kokanee salmon (Oncorhynchus nerka) takes place in the streams surrounding the lake. Mackinaw (Salvelinus namaycush) are believed to spawn in water deeper than 20 ft. Some non-game fish may utilize shallow cobbles for their spawning (e.g., sculpin: Cottus sp.) (pers. obser., Loeb). Overall, the reconstruction program will in no way degrade the fish habitat of fisheries of the area.

5. Sediment Transport

One of the major concerns and problems often associated with rock or earth structures extending from shore out into water bodies such as Lake Tahoe is their altering of longshore currents and, concomitantly, sediment deposition patterns. The sedimentology and littoral sediment transport characteristics of Lake Tahoe have been investigated and reviewed by Osborne et al. (1985). Those data will be used in conjunction with data collected as part of this assessment report to evaluate the sediment transport in the specific area surrounding the proposed pier reconstruction project.

The bathymetry around the existing pier was evaluated during the latter two site visits (November 7, 8, 1987). A qualitative appraisal of the area did not reveal any existing problems with disproportionate accumulations of sediment on opposing sides of the rock crib areas of the pier. On the north facing sides of the rock cribs (except cribs J and K) and west facing sides of the cribs which make up the boat houses,

there was a small trough directly against the pier. The trough was approximately 1-2 ft. wide and as much as 2 ft. deep. No undercutting of the actual structure of the pier was evident. The entire area outside the trough and those other areas around the pier where there was no trough was very flat. No sand or sediment ridges (e.g., sandbars) were observed although a slight uniform rippling of the sediments was observed (alignment approximately 45° to the shore) (Figure 2).

The sediment bathymetry was determined quantitatively around the pier for this report (Figure 2). These data revealed accumulation of sediments had occurred on the north facing side of the rock crib pier in some places. The sediment accumulation differences ranged from 0-20". The average was about 7" or slightly less.

Sediment samples (3) were collected adjacent to the pier to determine their organic matter content. One sample was collected within the boathouse on the end of the pier, another about 10 ft. away (northward) from the outer rock cribbing and a third about 50 ft. farther away towards the next pier (Figure 2). All samples had very low and similar amounts of organic content. The range was 0.83-1.10% organic content and the amounts between sites were not significantly different (Table 1). The sand sediments of the littoral area between Homewood and the Truckee River outflow have been described as volcanic in origin with a relative paucity of quartz and plutonic rock fragments (Osborne et al., 1985). The shorezone samples from the earlier study (1985) also showed a high degree of similarity to cliff-backshore (onshore) material (also see Section 5).

The study of Osborne et al. (1985) described the general sand

Figure 2. The bathymetric data collected around the Reid Dennis pier. The values are in units of elevation above sea level (ft.). The general substratum types are also mapped as are the locations of the sediment samples collected and the orientation of the sediment rippling. Cribs are identified by the letters A-K.

3
2
Sediment Samples

Approximate orientation
of rippling on
sediment surface

6225.24 ft
Shoreline (11-8-87)

Approximate beginning of
the vegetation

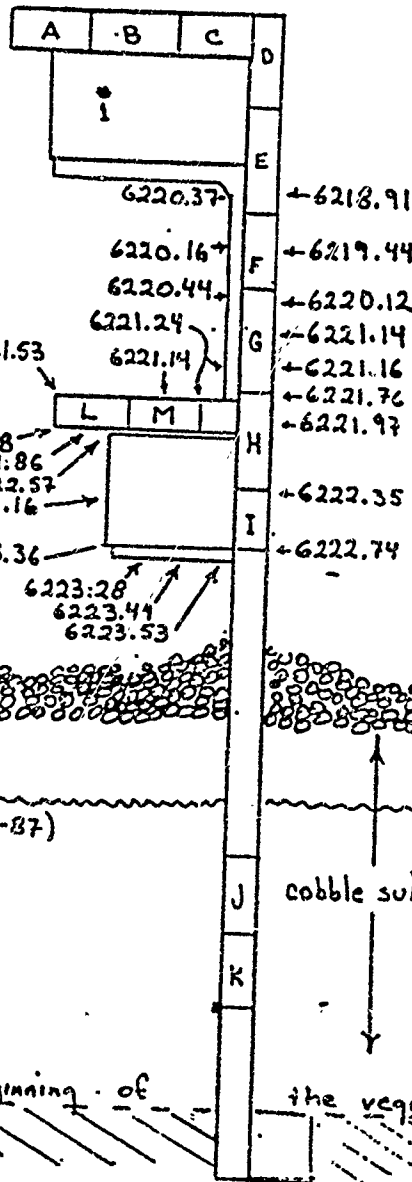
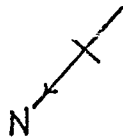

sand-silty
substrata

cobble substrata

Table 1. The organic content of sediments collected adjacent to the rock crib pier (1340 W Laked Blvd., Tahoe City, Placer County, California).

Sample	Organic Content (%)	Mean (\pm S.D.)
1.a.	1.10	
b.	0.95	1.03 (0.42)
2.a.	0.86	
b.	0.87	0.87 (0.01)
3.a.	0.94	
b.	0.92	0.93 (0.01)

transport direction in the area of the proposed project to be northward. The data collected as part of this environmental assessment somewhat contradicts that conclusion. A grain tracer analysis conducted during the earlier study at nearly the exact location of the proposed project, however, did not detect any movement of the sediments at water depths of 10 ft. and only onshore-offshore movement at 2 and 5 ft. depths. The dominant sand movement in the project area was determined to be onshore-offshore. The presence of a sublacustrine escarpment approximately 2,000 ft. south of the project site may have an effect on sediment transport in general for the area. The escarpment acts as a littoral barrier to sediment transport leading to the conclusion that shallow sediment transport in the littoral zone of Lake Tahoe is highly segmented or compartmentalized.

The overall conclusion about sediment transport problems associated with longshore currents at the specific site of the proposed project is that there is little evidence of any in the existing situation and none anticipated during or after the reconstruction. Possibly the open section of the pier (i.e., section without a rock crib) between the first boathouse and the shore-cribs may act to mitigate the potential impact on sediment transport often associated with rock crib piers.

6. Shoreline Erosion

There is a potential impact on shoreline erosion caused by structures like rock crib piers extending out into the lake. At present, there are two major natural sources of Lake Tahoe beach sand: fluvial inputs and cliff-backshore erosion. Compositional data from the

analysis of sediments near the proposed project found a high degree of similarity with the cliff-backshore material (Osborn et al., 1985). Fluvial inputs of sediment to the littoral area of concern in this report would be unlikely since the nearest stream inflow is 1.25 mi. south across the sublacustrine escarpment.

As discussed earlier in this report (Section 1), the shoreline above the high water line is well vegetated. No erosional problems were apparent during the site visit. Overall, shoreline erosion problems usually result from storm events during periods of high lake water levels. The amount of erosion can also depend on the wave direction, the duration of the wind and/or storm, and the presence of structures which may affect wave interaction with the shore (e.g., rock crib piers, retaining walls, marinas in the lake, etc.)

The existing conditions show no evidence of this pier causing accelerated shoreline erosion. The present shoreline appeared stable and unaffected by the presence of the pier. It should be noted that the pier also does not present a hazard to safe navigation extending only ca. 250 ft. offshore.

7. Mitigation of Any Potential Environmental Impacts

The proposed reconstruction project has been planned in such a way as to minimize any potential environmental impacts. The crib rock removal during the in-lake reconstruction of the decaying wood pilings, decking and crib support structures will be done in a "leap frog" manner in order to minimize disturbance to the benthic sediments. "Leap frog" in this case means the rocks which are removed from a crib will be placed in the adjacent crib until the wood repair is completed on the

emptied structure. Once repaired, the rocks will be returned to the reconstructed crib and the next crib will be repaired, its rock being placed in an adjacent crib. It is recommended that rocks from not be stored on the lake sediment while repair work is being conducted. Rocks from the two most shoreward cribs (cribs J and K) could be stored on the beach, although, this activity should be handled with care so as not to disturb the soils. No heavy equipment should be used on the beach itself without careful consideration of the potential for erosion and/or sediment generation.

Overall, there are no serious problems anticipated during the reconstruction associated with environmental degradation. Using accepted methods for this type of work in Lake Tahoe and demonstrating concern and awareness of the environment should eliminate any potential impacts the proposed project may have on the environmental quality of the area.

8. Alternatives to Reconstruction

The propose reconstruction of the existing rock crib pier is believed to be the best choice in this situation. Possible alternatives include the following: (1) allow the pier to continue to decay; (2) remove the rock cribbing and pier from the lake; and (3) replace the rock crib pier with an open piling pier (with or without removal of the existing pier).

The first alternative is unacceptable. Allowing the structure to continue to decay would create an unsafe situation. Eventually, use and access to the structure would need to be restricted and prohibited as conditions became more and more dangerous. If the pier collapsed or the

wood structures began to fragment, the debris would be aesthetically unacceptable and possibly cause navigational safety problems.

The second alternative would operationally cause more potential environmental disturbance than reconstruction. Removal of the pilings, rocks and crib work from the lake would necessitate disturbing the sediments. There is no reason to believe removing the pier would improve the existing environment. To the contrary, to some extent the pier has increased rock substratum availability having a potential positive effect on the fish habitat (see Section 3). Although not an environmental issue, the structure also affords its users personal enjoyment and increases recreational activities. Pier removal does not appear to be justified in this situation since no net gain to the environment seems to be definable.

The third alternative, replacing the existing rock crib pier with an open piling pier, can be considered in two ways: (1) replacement after the existing pier is removed, or (2) replacement without removing the existing pier. The removal of the rock crib structures was previously discussed in this section. The procedure would possibly cause environmental degradation (e.g., disturbance of the sediments) and no definable improvement to the existing environment. No problems have been identified associated with the rock crib pier at this particular site concerning water quality (Section 2), fish habitat and fisheries, (Section 3), sediment transport (Section 4) or shoreline erosion (Section 5). Removal of the pier and replacing it with an open piling pier does not appear to be necessary. Neither does it appear beneficial to leave the existing pier in place to continue to decay while building

a new open piling pier to replace it. Again, no net improvement in the environment would be gained in this case by building a new open piling pier.

Based on an evaluation of the present environment and those areas of concern raised by the many agencies charged with the responsibility of maintaining and regulating the environmental quality of Lake Tahoe's shoreline, the conclusion is the reconstruction of the existing pier is the best alternative. The methods to be used during the reconstruction project appear to be appropriate in order to minimize or eliminate potential environmental degradation of Lake Tahoe.

CALENDAR PAGE	237
MINUTE PAGE	298

9. References

Loeb, S.L. 1987. Groundwater quality within the Tahoe basin.

Institute of Ecology, University of California, Davis. 280 p.

Osborne, R.H., M.C. Edelman, J.M. Gaynor, J.M. Waldron. 1985.

Sedimentology of the littoral zone in Lake Tahoe, California,

Nevada. Dept. of Geological Sciences. University of Southern

California, for the California State Lands Commission. 88 p.

TRPA. 1986. Proceeding of: Symposium on fisheries and fish habitat in

Lake Tahoe. Tahoe Regional Planning Agency publication, Zephyr

Cove, Nevada. 34 p.

10. Photographs of Pier and Sediments

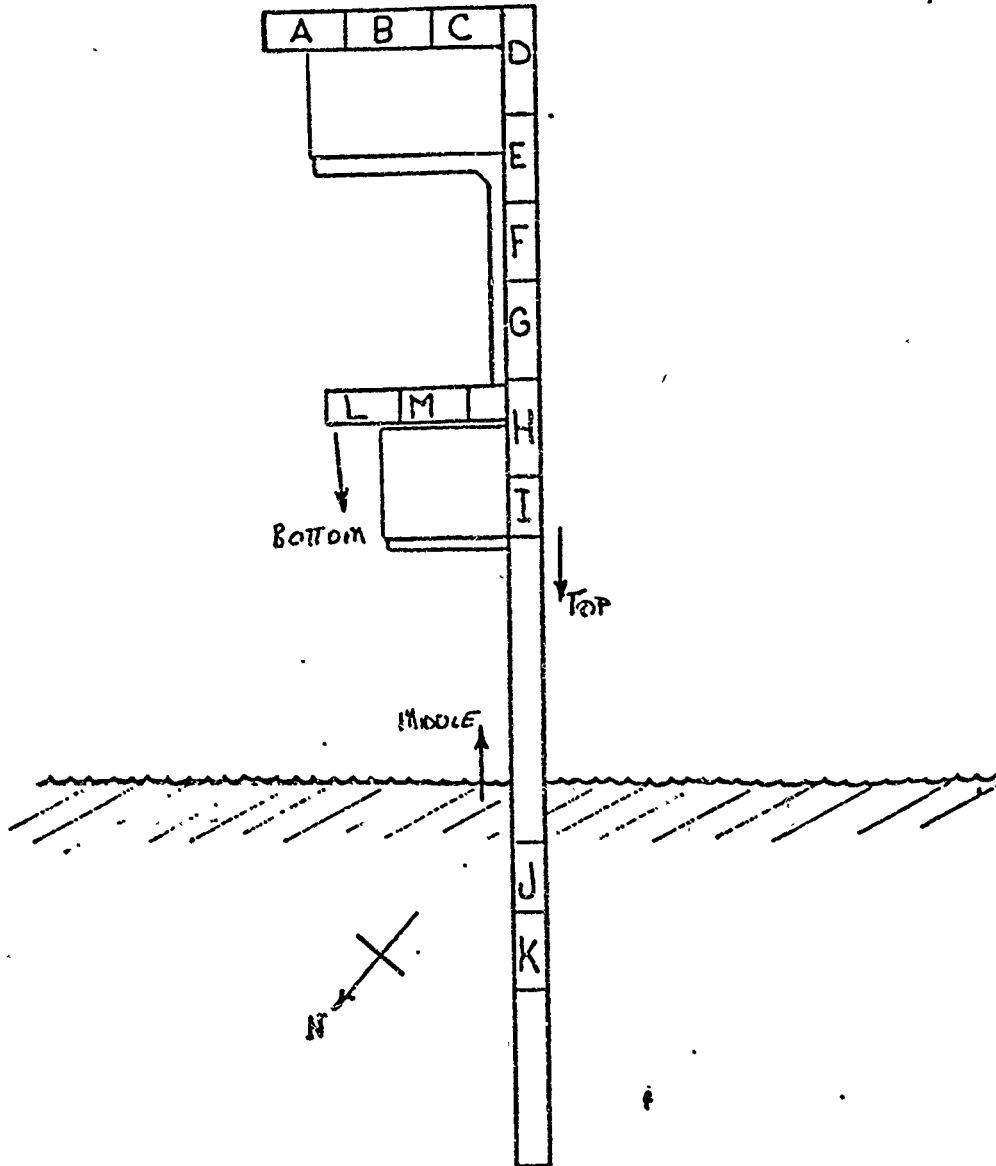

301
2410

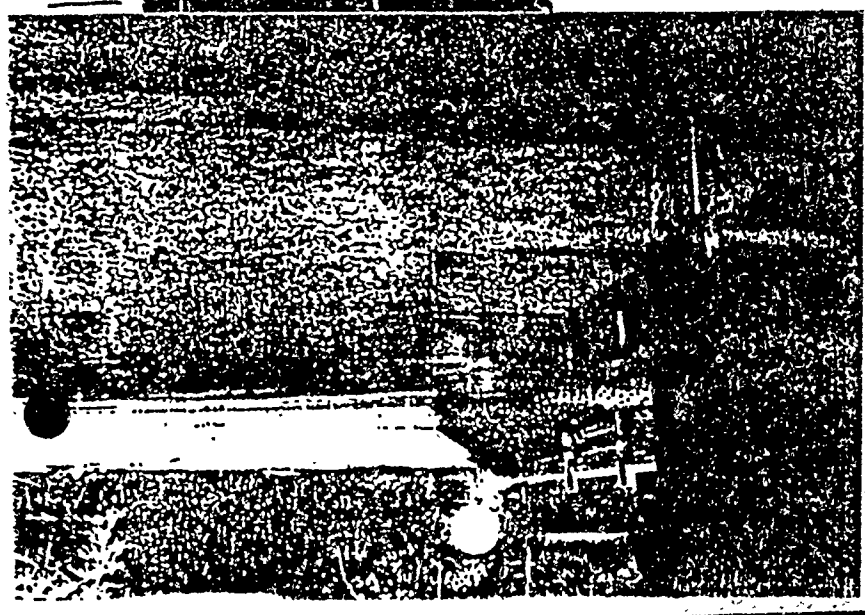

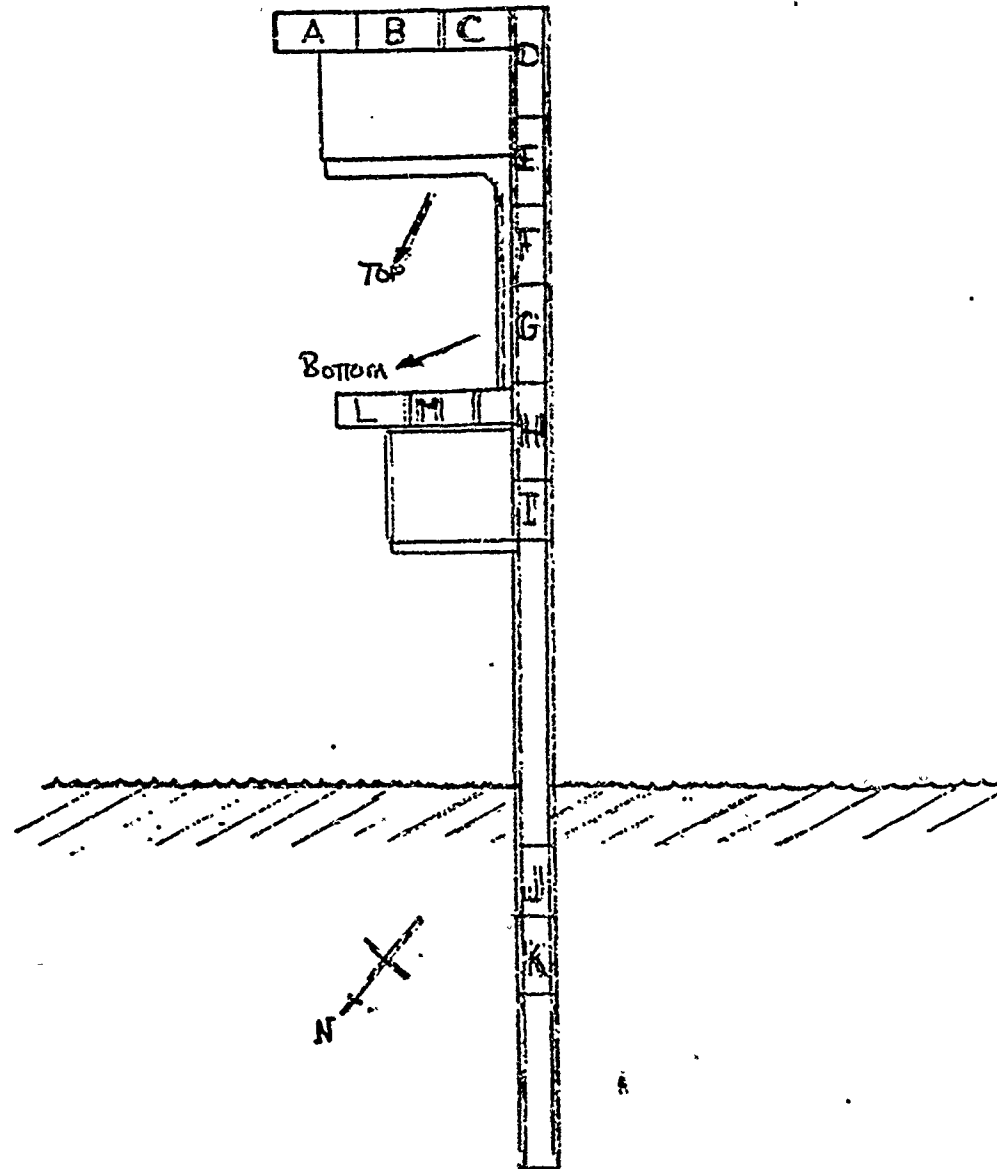

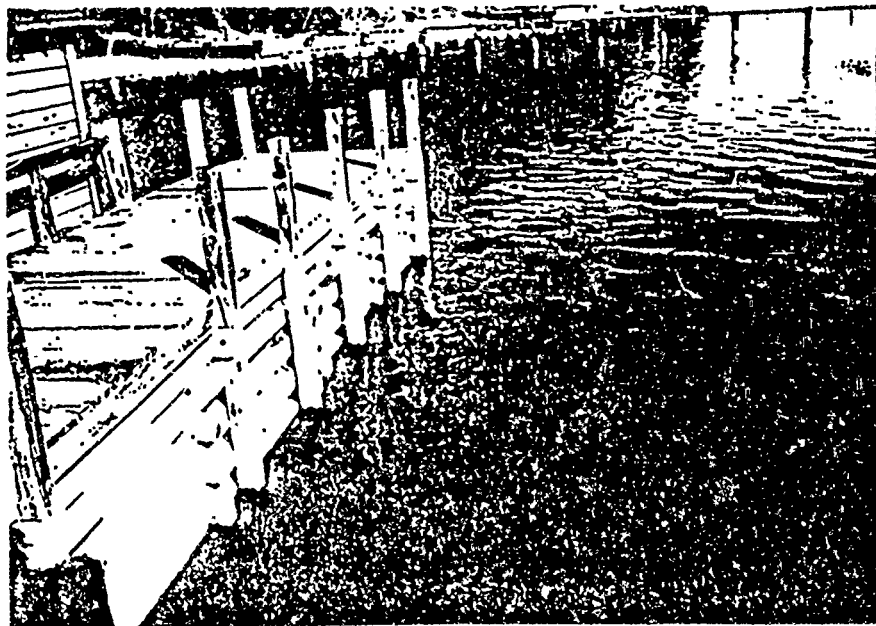
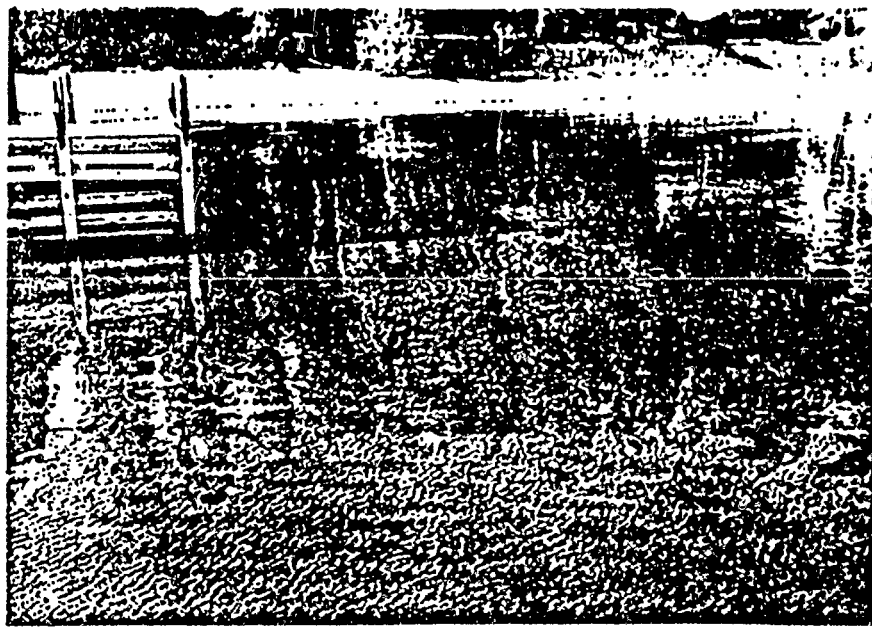

CALENDAR PAGE	243
MINUTE PAGE	304

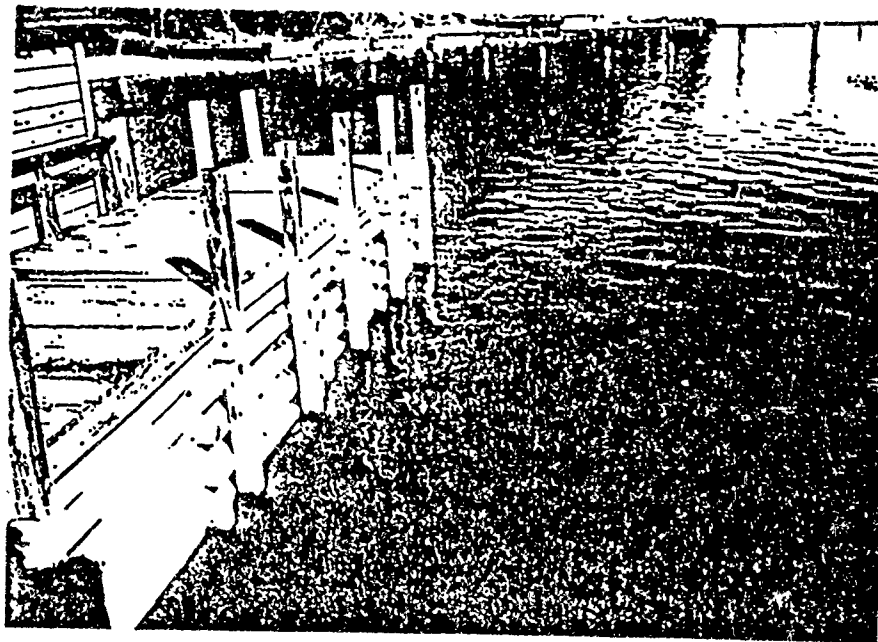

CALENDAR PAGE	244
MINUTE PAGE	305

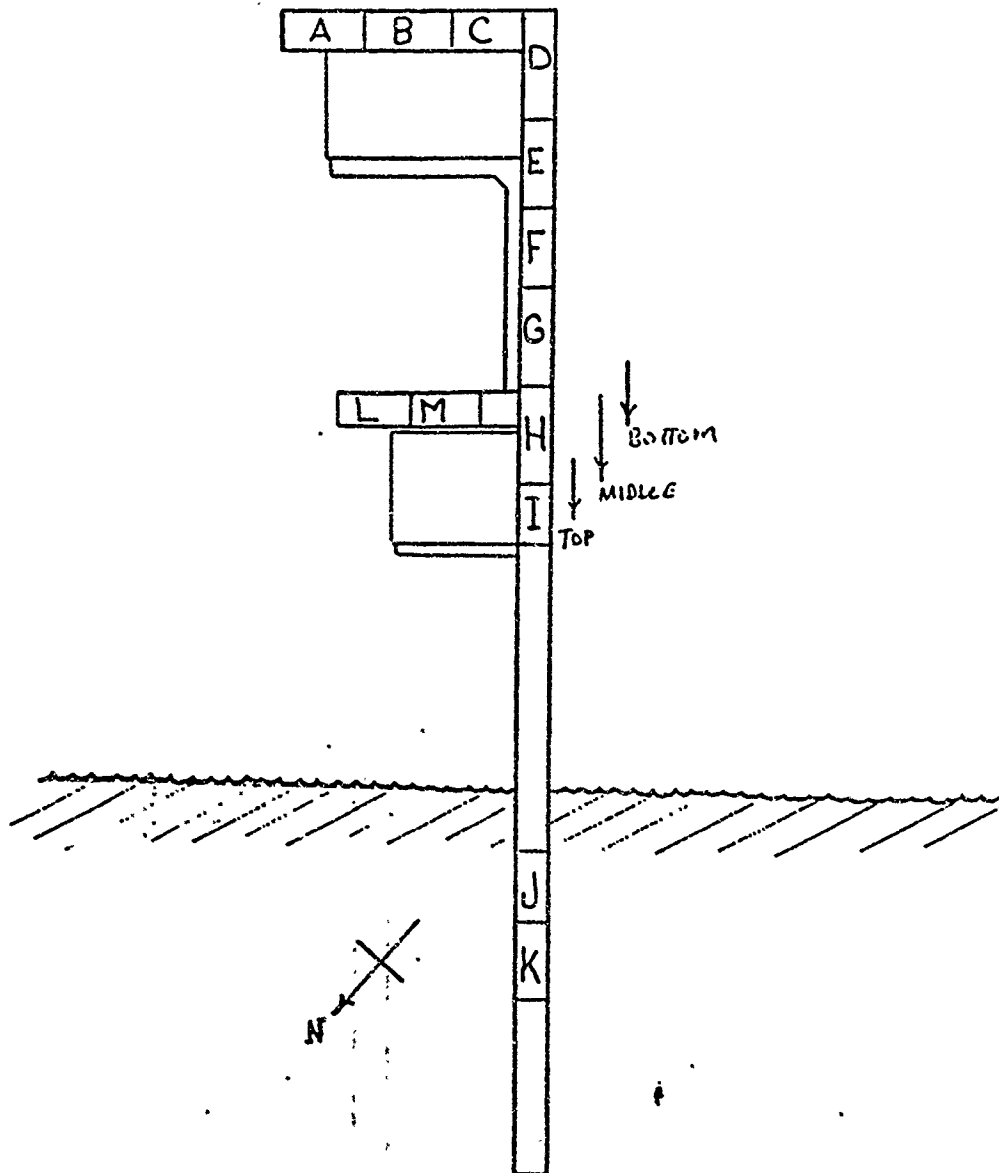

CALENDAR PAGE	245
MINUTE PAGE	306

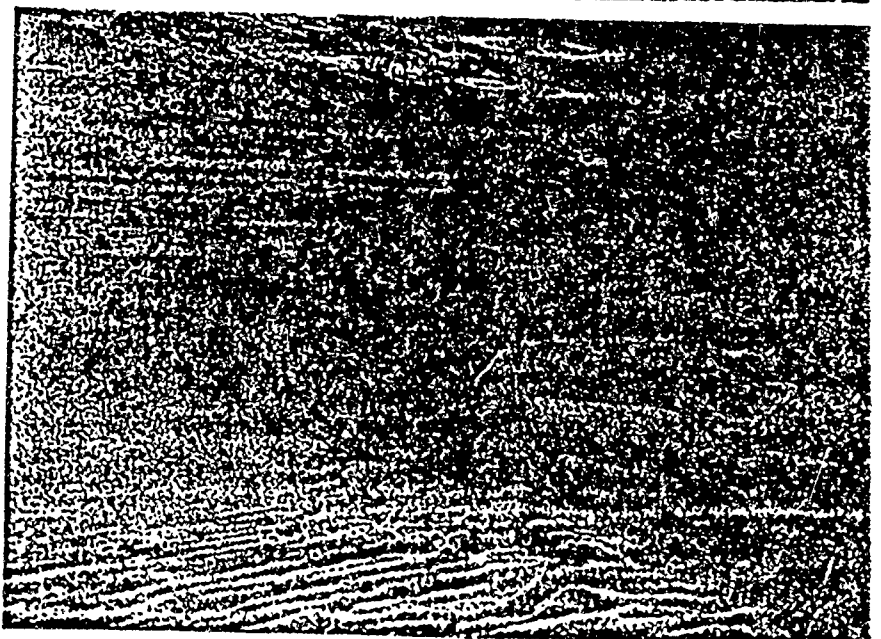
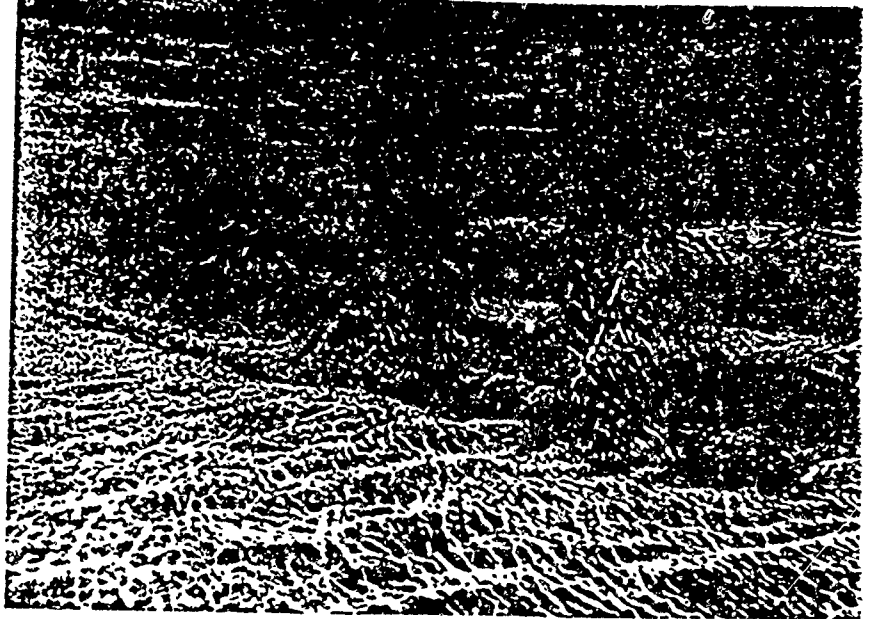
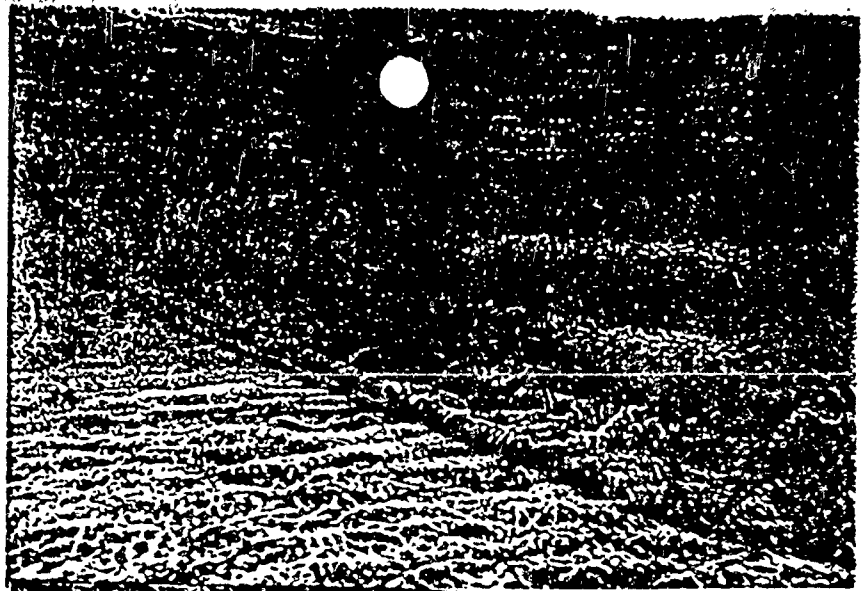

CALENDAR PAGE	246
MINUTE PAGE	307

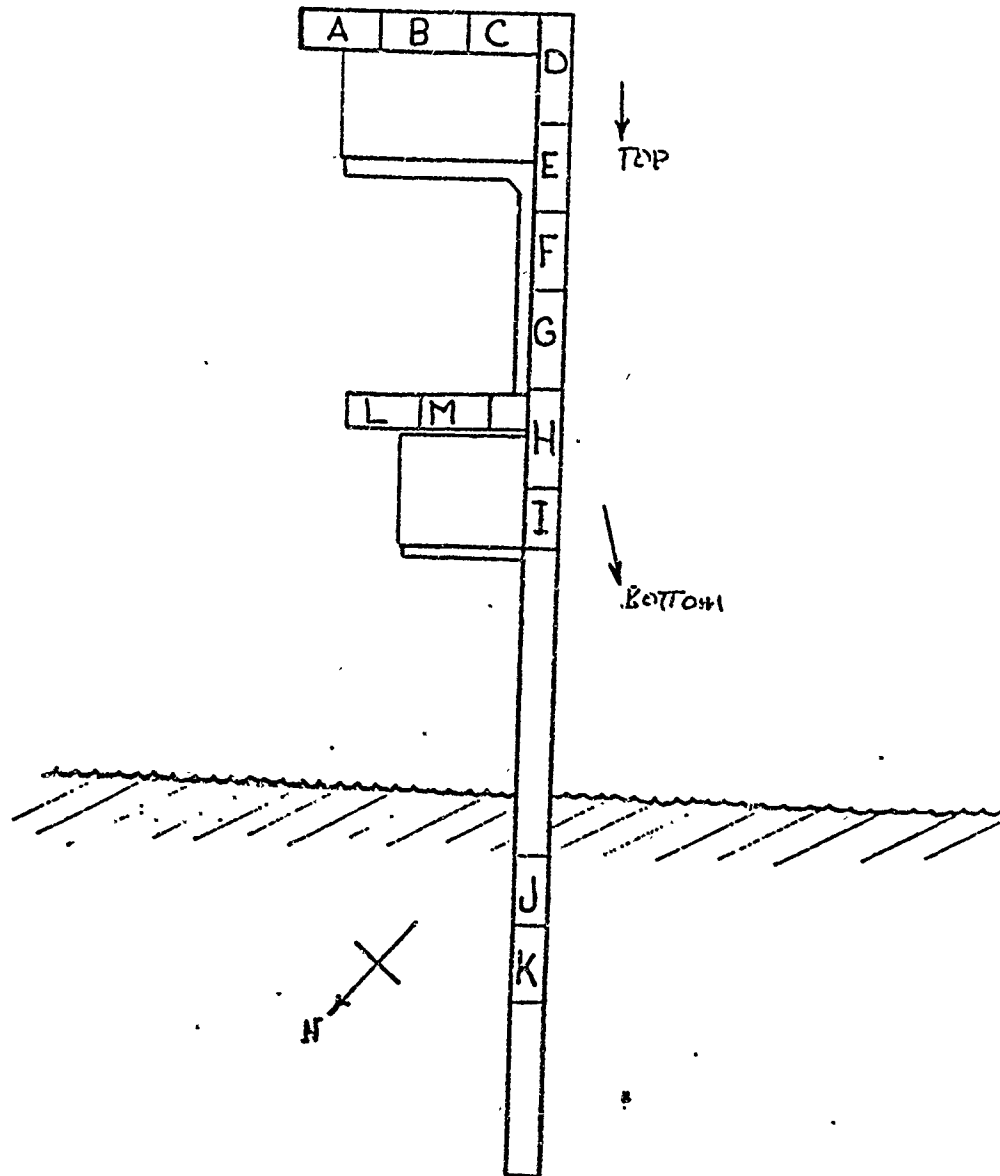

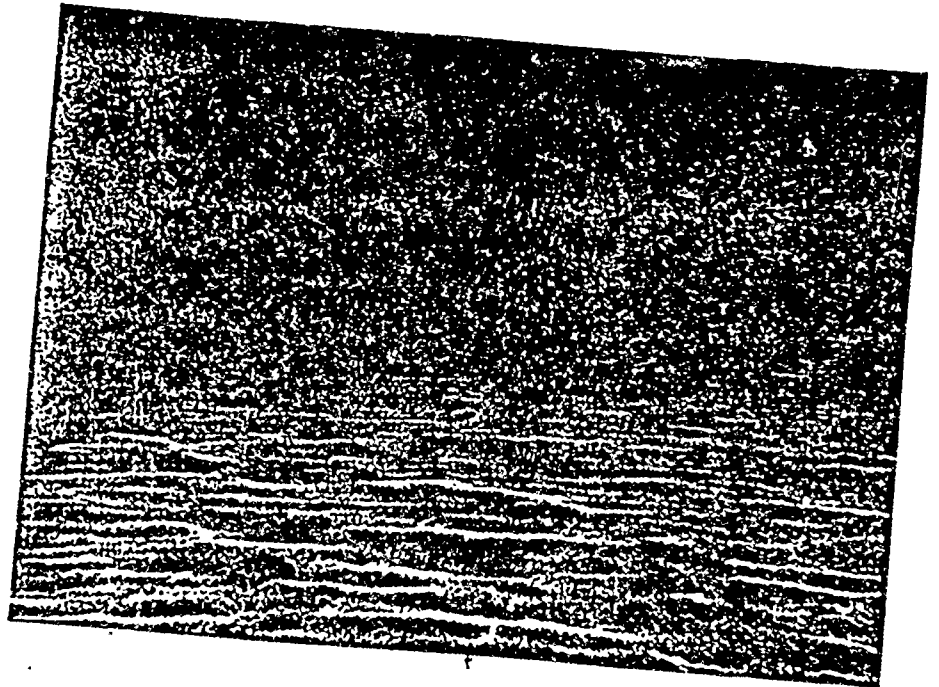
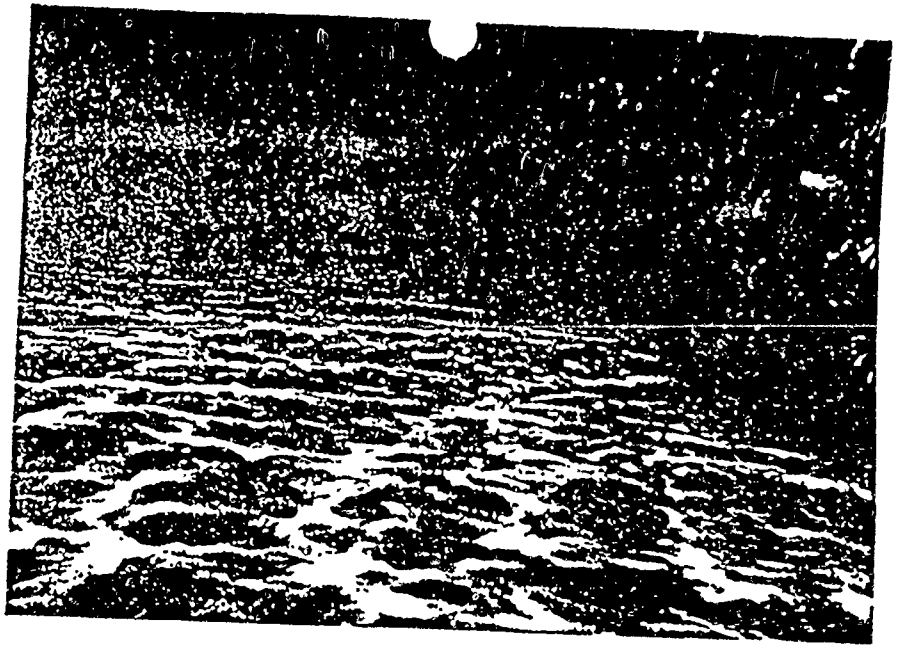

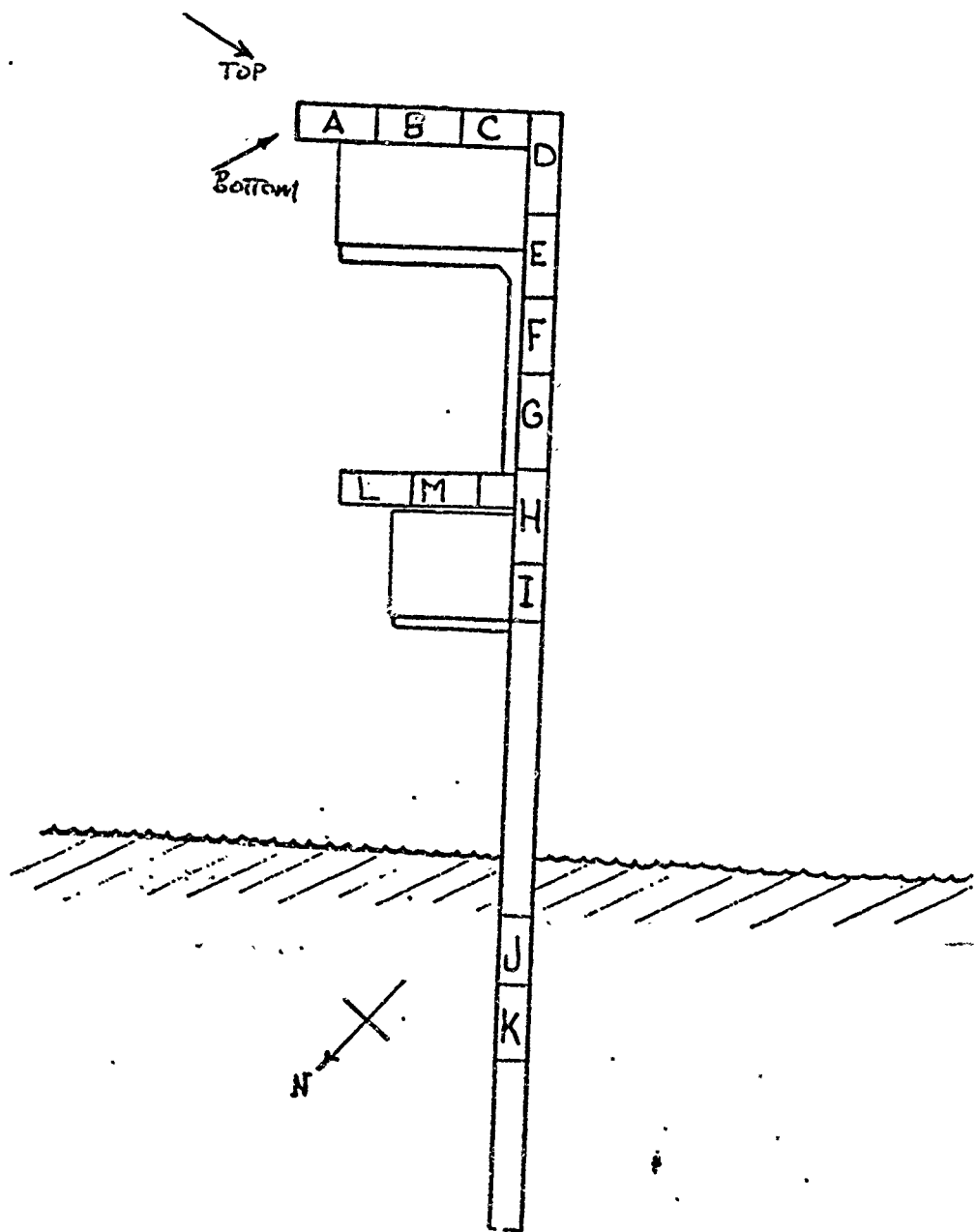

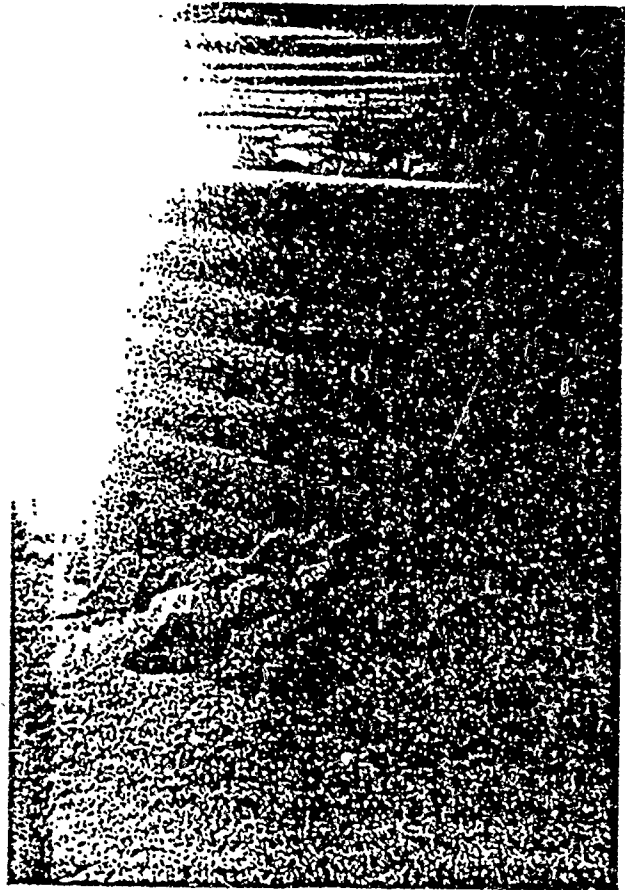
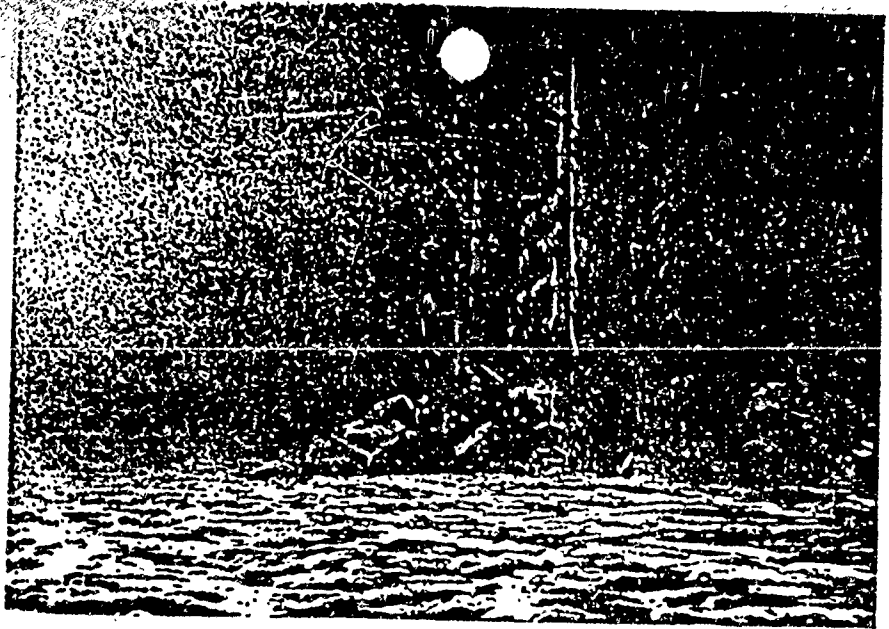

CALENDAR PAGE	250
MINUTE PAGE	311

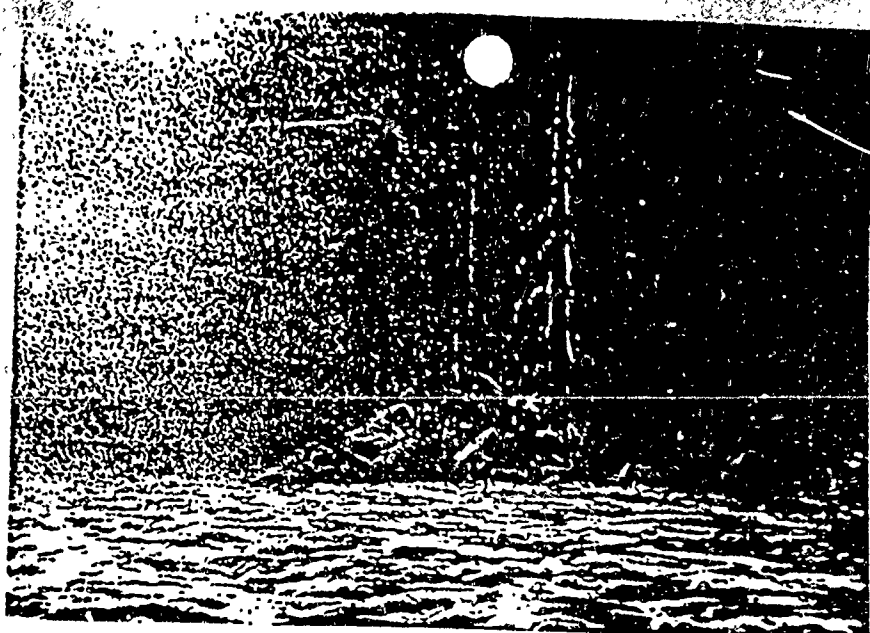

CALENDAR PAGE	<u>251</u>
MINUTE PAGE	<u>312</u>

RVA - TAHOE
MAR 25 1988
RECEIVED

Supplement to:

ENVIRONMENTAL ASSESSMENT

Reconstruction of a Rock Crib Pier
Ried Dennis, Owner

(January 11, 1988)

March 24, 1988

Prepared by:

Stanford L. Loeb, Ph.D.
Consultant
515 Dexter Lane
West Lafayette, Indiana 47906

CALENDAR PAGE	252
MINUTE PAGE	313

Introduction

At the request of the California State Lands Commission (February 4, 1988; Ted T. Fukushima), and a more detailed bathymetric map was prepared and an analysis of the grain size distribution around the pier was completed. These additional studies were performed in order to better understand the potential impact of the rock crib pier on sediment transport in the littoral zone of Lake Tahoe. The plan and design of these studies were discussed and approved by the State Lands Commission (2/18/88).

Bathymetry-Topography

A series of transects (6) were laid out perpendicular to the shoreline along which 56 measurements were made in order to construct the bathymetric-topographic map (Figure 1). Several features were evident from this mapping. The map illustrates an accumulation of material directly under the pier nearest the shore. This material is composed entirely of cobbles (1-12" diameter) which is the substratum type out to the 6,224 ft. elevation contour line. This accumulation directly under the open pier (no crib present in this area) may have been partly man-made and not due entirely to natural processes.

The slope of the sediments beyond the 6,224 ft. contour on the southward side of the pier is slightly steeper than on the northward side (9% versus 7% between the 6,224 ft. and the 6,217 ft. contour lines). The sediments southward of the pier show a slight deepening (i.e., sediment displacement) within an "affected area" extending a distance of 5 to 15 ft. away from the pier. The estimated "affected area" was determined assuming the "unaffected" bathymetric contours would be parallel to the shore.

On the northward side of the pier, the sediments appear virtually

Figure 1. Bathymetric-Topographic map of area surrounding the pier at 1340 W. Lake Blvd., Tahoe City, Placer County, California, A.P.N. 83-162-12. Locations where sediment cores were collected are also noted (C1-6).

CALENDAR PAGE	254
MINUTE PAGE	315

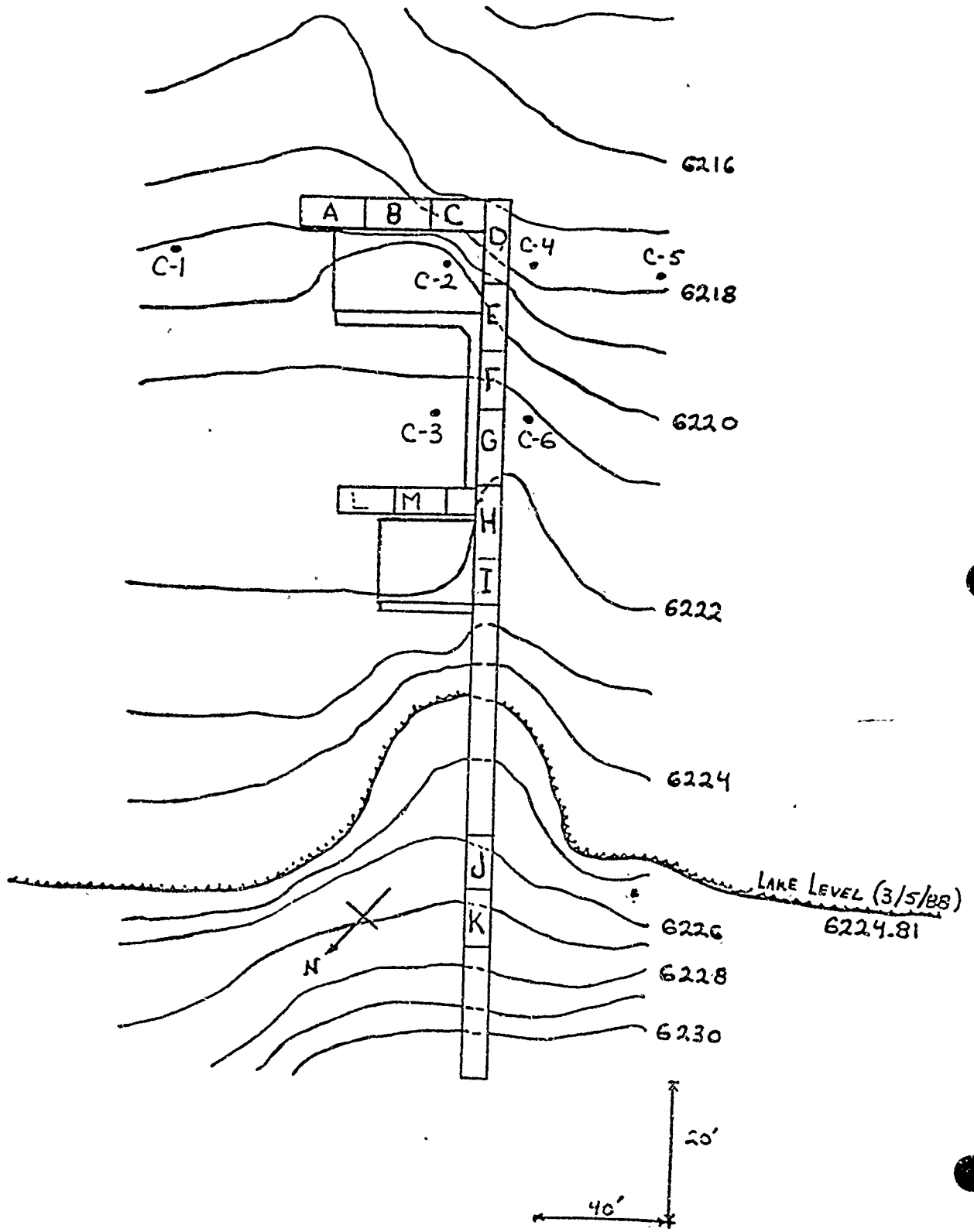

CALENDAR PAGE	255
MINUTE PAGE	316

unaffected outside the cobble zone (6,223 ft.) (i.e., the contours are parallel to shore). There is a small mound present inside the outer boat house. To what extent this situation has resulted from boat activity (e.g., propeller driven currents) rather than natural lake processes is difficult to determine. The overall disposition of the sediments on the northward side appears virtually flat and even for the most part. There is, however, an apparent accretion of sediments on this side compared to the southward side beyond the 6,222 ft. contour. Inside the 6,222 ft. contour, the trend is reversed. Whether this apparent difference is due to the presence of the pier is not certain. Sediment grain size analyses presented later in this report will discuss this possibility.

The sediments outside the outer rock crib pier possibly indicate a wave refraction effect of the rock crib pier on sediment transport (contours 6,217 ft. and 6,218 ft.). If the predominant winds and concomitant waves are from the southwest, the apparent ridge may have resulted in part from such a diffraction effect. Again, this possibility will be discussed further in the following section.

Sediment Grain Size Distribution

A series of sediment cores were collected (March 5, 1988) for grain size analyses. A plexiglas tube (c.a., 2" diameter) was used to core the surficial sediment (0-5") via SCUBA. The objective of this work was to determine if there were significant differences in the grain size distribution of the sediments around the pier. The hypothesis being tested was that if the rock crib pier interferes with littoral sediment transport, a greater amount of fine particles (silts, clays and fine sands) will accumulate on the leeward (wind

protected) side compared to the windward side.

A total of six cores were analyzed: three from the leeward side (C-1,2,3) (Figure 1). A standard sieve analysis was made on each sample. On one sample (C4), a replicate analysis was performed to determine the error associated with these measurements. Sieve sizes used were 30, 50, 100, and 200 (U.S. Standard Sieve series). (Analysis performed by Mr. Bradley E. Vote, Civil Engineer and Geologist.)

Review of the data demonstrated the composition of the sediments in all cores was nearly identical (Table 1). In only one sample (C6) was the amount of fine material significantly less than its paired sample (C3). Significance was based on a difference greater than two times three standard deviation units (S.D. = 0.71). In the other paired samples, no significant differences were detectable (C1-C5, C2-C4). The mean percentage composition of silts on the leeward side of the pier was 12 ± 3 compared to 9 ± 3 . These values are not significantly different.

Table 1. Sediment grain size distribution for cores collected around the rock crib pier (R. Dennis, owner). Data presented represents the percentage of sand versus silts and clay for each core (C1 through C6 and the replicate C4_{1,2}).

	C1	C2	C3	C4 ₁	C4 ₂	C5	C6
Sand (%)	91	87	86	89	90	89	95
Silt/Clay (%)	9	13	14	11	10	11	5

Analysis of the sand fractions for each core revealed that finer sands were present on the windward side compared to the leeward side in six of nine pair-wise comparisons (Table 2). Of these, only three pair-wise comparison

differences appeared statistically significant (2 at $P < 0.05$; 1 at $P < 0.01$). These results are also presented in a graphical form (Figure 2 a-g). These illustrations further support the general similarity of the sediments grain size distribution in the area surrounding the pier.

Table 2. Percentage of material passing through the sieve for each screen size. Significant differences are noted for sediments finer than their paired sample (*, $P < 0.05$, ** $P < 0.01$). Pairs are C1-5, C2-4 and C6-3. C4 is the mean of the 2 replicates.

Sieve	Leeward Cores			-	Windward Cores		
	C1	C2	C3		C4	C5	C6
30	100	100	100		100	100	100
50	67	71	64		83*	84*	82**
100	27	37	33		39	39	28
200	9	13	14*		10	11	5

The hypothesis presented earlier in this report implied that finer sediments should accumulate leeward of the rock crib pier if the structure had an impact on littoral zone transport of sediments. The data presented here do not indicate such an impact exists.

Conclusions

The rock crib pier at this specific location (1340 W. Lake Blvd., Tahoe City, Placer County, California, A.P.N. 83-162-12) does not appear to have a major impact on the littoral transport of sediments. The apparent discontinuity in the sediment deposition around the pier is very localized and may be characteristic of the area in general. Examination of the overall bathymetry near this site reveals a significant sublacustrine escarpment just south of the site which may control the sediment transport in the region. The study by Osborn et al. (1985) suggested that this area had mainly

Figure 2a-g. Graphical presentation of the sediment grain size distribution (sieve analyses) from cores collected around the pier. Note that 2d and 2e are replicate analyses of C4.

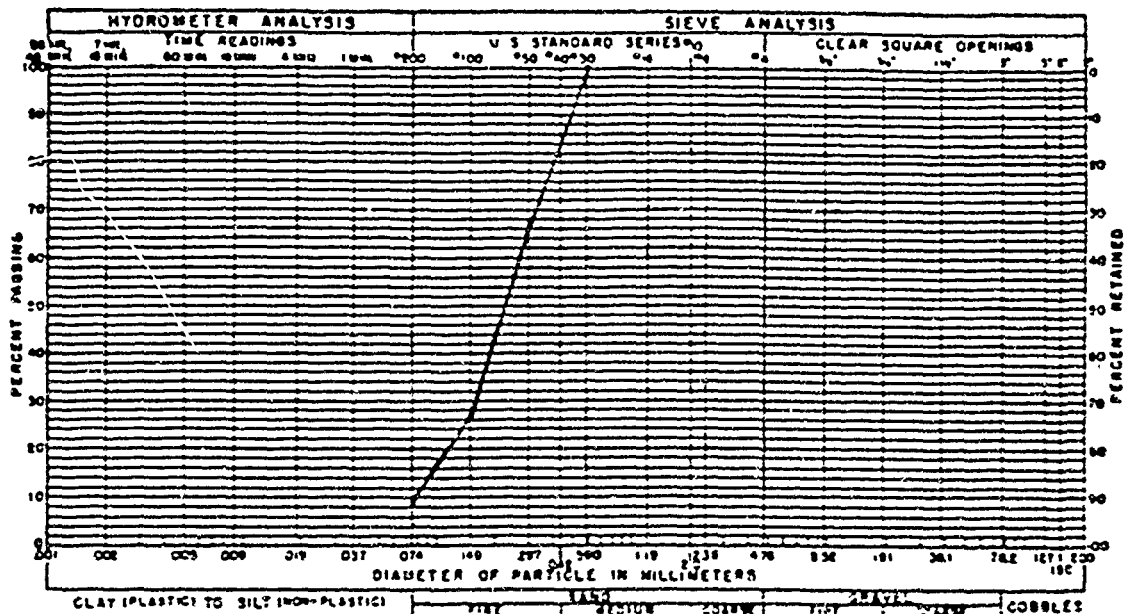

GRAVEL 0% SAND 91% SILT AND CLAY 9%

LIQUID LIMIT ---% PLASTICITY INDEX ---%

SAMPLE OF SAND FROM LOES 1

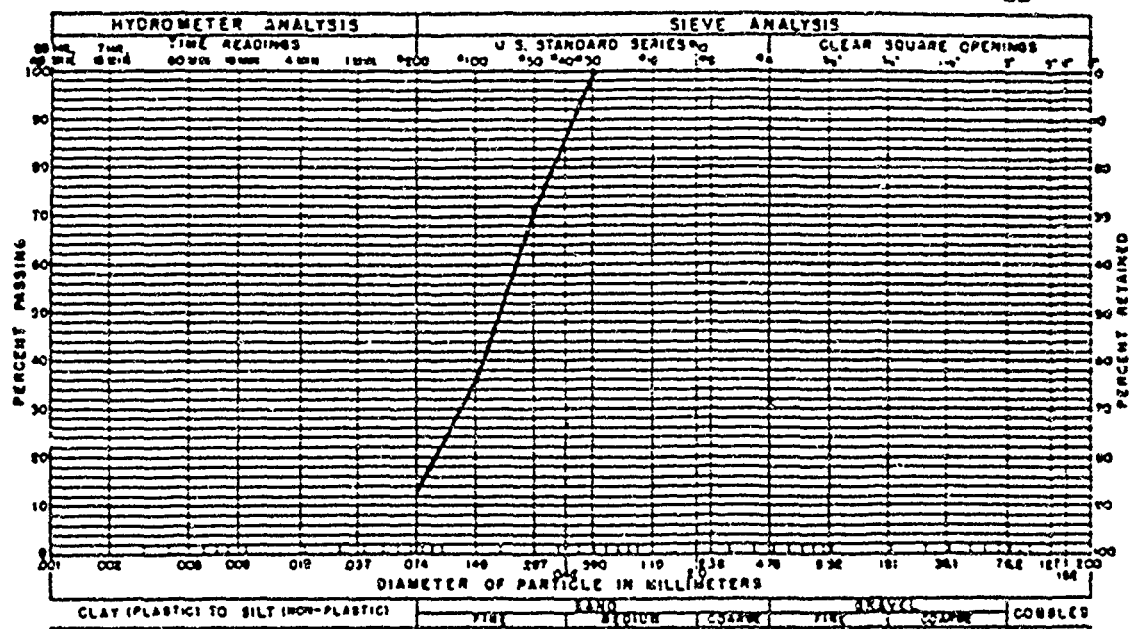

GRAVEL 0% SAND 87% SILT AND CLAY 13%

LIQUID LIMIT ---% PLASTICITY INDEX ---%

SAMPLE OF SAND FROM LOES 2

GRADATION TEST RESULTS

CALENDAR PAGE	260
MINUTE PAGE	321

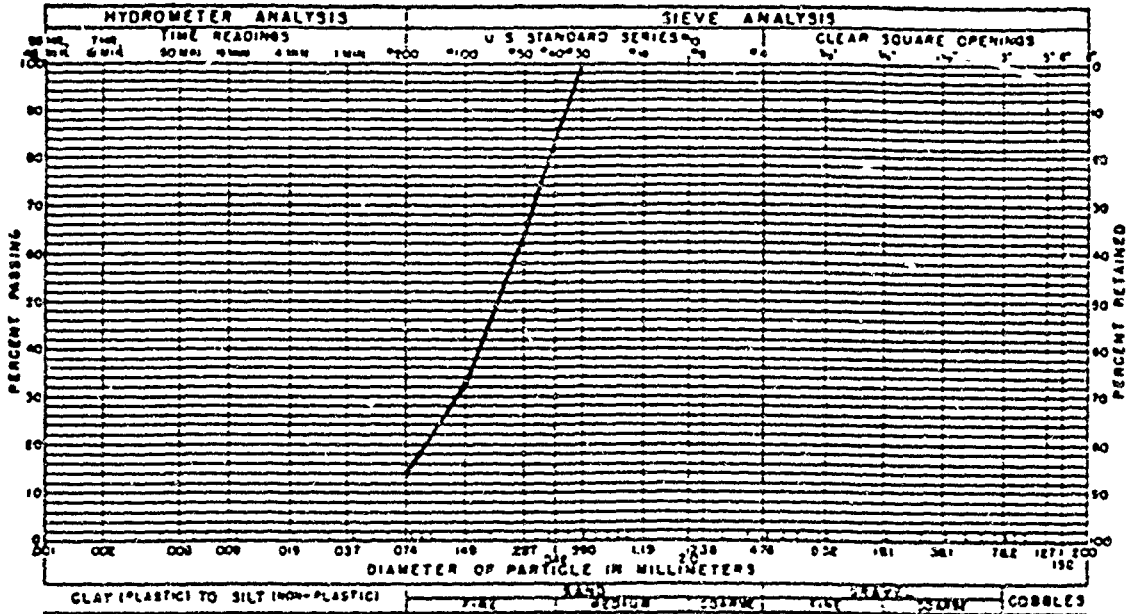

GRAVEL 0 % SAND 36 % SILT AND CLAY 14 %
 LIQUID LIMIT --- % PLASTICITY INDEX --- %
 SAMPLE OF SAND FROM LOEB 3

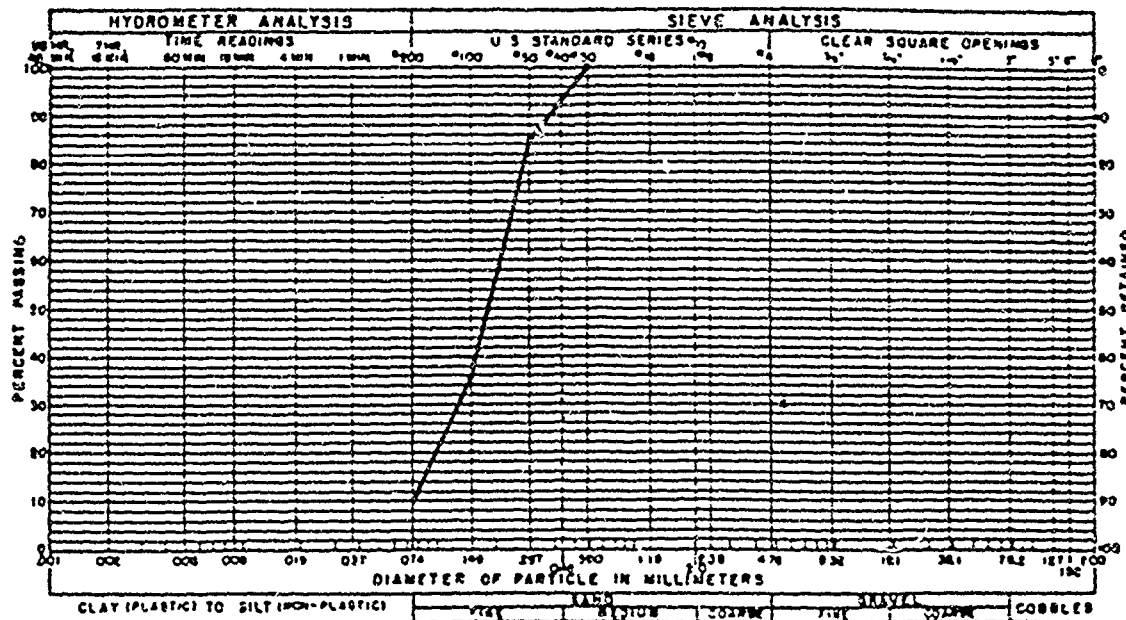

GRAVEL 0 % SAND 89 % SILT AND CLAY 11 %
 LIQUID LIMIT --- % PLASTICITY INDEX --- %
 SAMPLE OF SAND FROM LOEB 4

GRADATION TEST RESULTS

CALENDAR PAGE	261
MINUTE PAGE	322

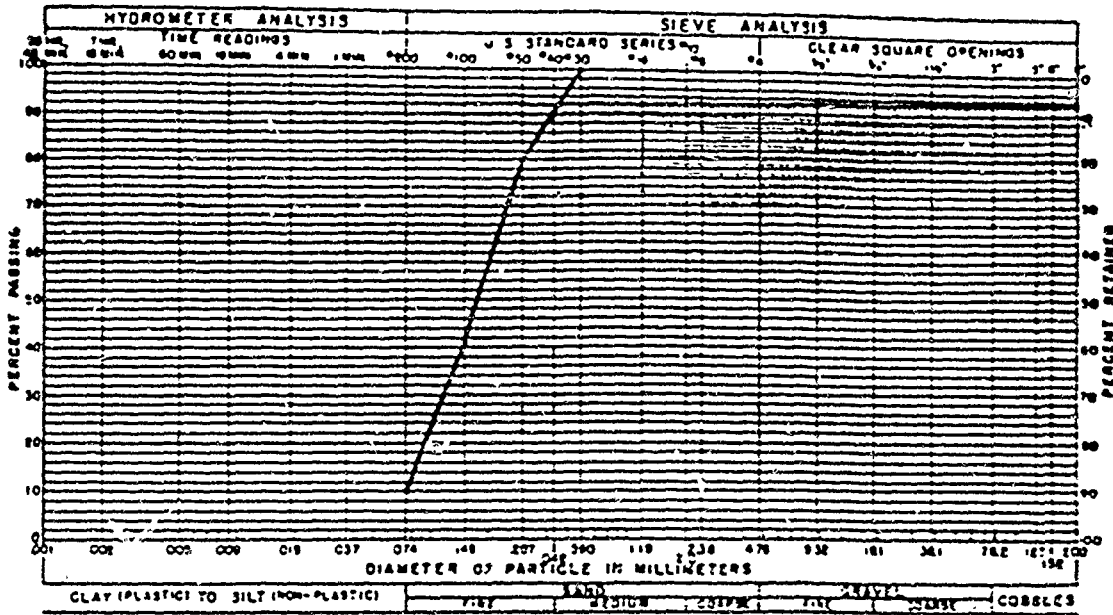

SAMPLE OF SAND FROM LOEB 4

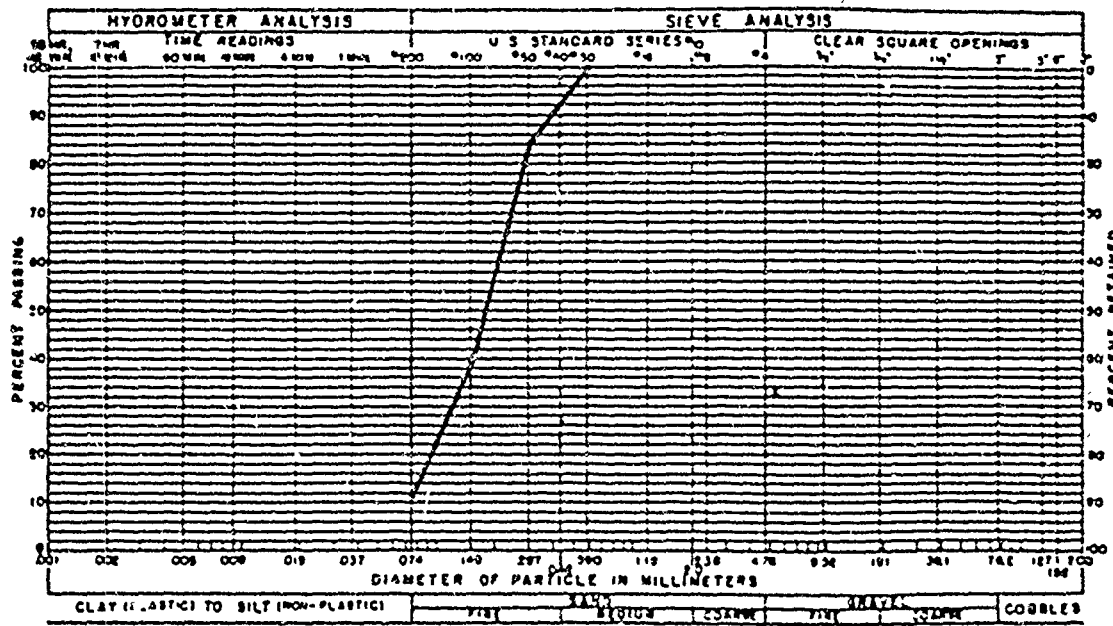

SAMPLE OF SAND FROM LOEB 5

GRADATION TEST RESULTS

CALENDAR PAGE	262
MINUTE PAGE	323

0.375 19

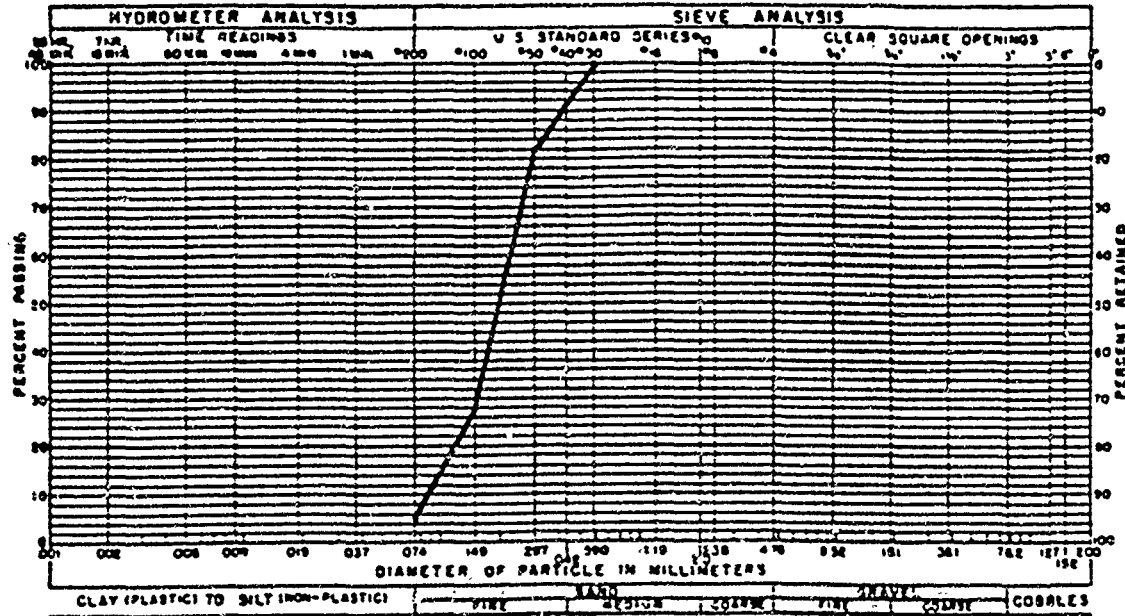

GRAVEL	0 %	SAND	95%	SILT AND CLAY	5 %
LIQUID LIMIT	---	%	PLASTICITY INDEX	---	%
SAMPLE OF SAND			FROM LOEB 6		

GRADATION TEST RESULTS

CALENDAR PAGE	263
MINUTE PAGE	324

onshore-offshore movement of sediments which may explain the distribution of sediments observed around the pier.

The data collected during this study do not indicate any major effect of this particular pier on sediment transport. Such is not the case in all areas of the littoral zone of Lake Tahoe (e.g., along the southern end of the lake). The existing pier has been in place for around 30-50 years, therefore, any detrimental effects should have been readily apparent. No impacts are anticipated during or after the proposed reconstruction project. The other parameters of concern to the California Department of Fish and Game, Lahontan Regional Water Quality Control Board, United States Corp of Engineers, Tahoe Regional Planning Agency, and the California State Lands Commission, were included in the initial Environmental Assessment (January 11, 1988).

CALENDAR PAGE	264
MINUTE PAGE	325